



EN

Reverse-cycle air/water heat pumps with domestic hot water production, axial-flow fans and water pump assembly.

nadisystem

**AWR-MTD2-XE**  
**0011÷0091**

r HFC  
R-410A

**DeLonghi**

*Professional*

<b>U I A</b>	General warnings	3	<b>A</b>	Checking and starting up the unit	36
<b>U I A</b>	Waiver of liability	3	<b>A</b>	Description of room controller buttons and display	38
<b>U I A</b>	Fundamental safety rules	3	<b>A</b>	Operation and functions of the room controller	39
<b>I A</b>	Receiving and handling the product	4	<b>A</b>	Control and operating characteristics	48
<b>U I A</b>	Unit identification	5	<b>U I A</b>	System configuration	53
<b>I A</b>	Description of standard unit	6	<b>A</b>	Maintenance and service	59
<b>I</b>	Dimensioned drawings	7	<b>A</b>	Peak limiter alarm signals	61
<b>I</b>	Installation	7	<b>A</b>	Shutting down for long periods	62
<b>I A</b>	Water connections	8	<b>A</b>	Scheduled maintenance	62
<b>I A</b>	Electrical connections	11	<b>A</b>	Unscheduled maintenance	63
<b>I A</b>	Installer connections	12	<b>A</b>	Disposal	63
<b>I A</b>	Mains power supply connections	15	<b>U I A</b>	List of parameters	64
<b>I A</b>	Installer connections	14	<b>U I A</b>	Installer operations CHECKLIST	66
<b>I A</b>	General technical data	32			
<b>I A</b>	Operating limits	33			
<b>I A</b>	Pump curve	34			

The following symbols are used in this publication and inside the unit:



User



Important



Danger high temperatures



Installer



Prohibition



Assistance



Danger voltage



Eurovent certification program.

The manufacturer reserves the right to modify the data in this manual without warning.

**⚠** These appliances have been designed to chill and/or heat water and must be used in applications compatible with their performance characteristics; these appliances are designed for residential or similar applications.

Incorrect installation, regulation and maintenance or improper use absolve the **manufacturer** from all liability, whether contractual or otherwise, for damage to people, animals or things.

Only those applications specifically indicated in this list are permitted

**Read this manual carefully.** All work must be carried out by qualified personnel in conformity with legislation in force in the country concerned.

**The warranty is void** if the above instructions are not respected and if the unit is started up for the first time without the presence of personnel authorised by the Company (where specified in the supply contract) who should draw up a "start-up" report.

**The documents supplied with the unit** must be consigned to the owner who should keep them carefully for future consultation in the event of maintenance or service. All repair or maintenance work must be carried out by the Company's Technical Service or qualified personnel following the instructions in this manual.

The air-conditioner must under no circumstances be modified or tampered with as this may create situations of risk. Failure to observe this condition absolves the manufacturer of all liability for resulting damage.

## WAIVER OF LIABILITY

This publication is the sole property of **Manufacturer**. Any reproduction or disclosure of such is strictly prohibited without the written authorisation of **Manufacturer**.

This document has been prepared with maximum care and attention paid to the content shown. Nonetheless, **Manufacturer** waives all liability deriving from the use of such document.

Read this document carefully. All work must be performed, components selected and materials used in complete accordance with the legislation in force in material in the country concerned, and considering the operating conditions and intended uses of the system, by qualified personnel.

## FUNDAMENTAL SAFETY RULES

When operating equipment involving the use of electricity and water, a number of fundamental safety rules must be observed, namely:

**⚠** **The unit must not be used** by children or by unfit persons without suitable supervision.

**Do not touch the unit** with bare feet or with wet or damp parts of the body.

**Never perform any cleaning operations** before having disconnected the unit from the mains power supply.

**Do not modify safety** or control devices without authorisation and instructions from the manufacturer.

**Do not pull**, detach or twist the electrical cables coming from the unit, even when disconnected from the mains electricity supply.

**Do not open doors or panels** providing access to the internal parts of the unit without first ensuring that the switch QF1 is in the OFF position (see the wiring diagram).

**Do not introduce pointed objects** through the air intake and outlet grills.

**Do not dispose of**, abandon or leave within reach of children packaging materials (cardboard, staples, plastic bags, etc.) as they may represent a hazard.

**⚠** **Respect safety distances** between the unit and other equipment or structures. Guarantee adequate space for access to the unit for maintenance and/or service operations.

**Power supply:** the cross section of the electrical cables must be adequate for the power of the unit and the power supply voltage must correspond with the value indicated on the respective units. All units must be earthed in conformity with legislation in force in the country concerned.

**Terminals 6, 7, 9, 10, 11, 12, 13, 21, 22, 23, 24**, may be live even after the unit is disconnected. Make sure power is not connected before proceeding.

**Water connections** should be carried out as indicated in the instructions to guarantee correct operation of the unit. Add glycol to the water circuit if the unit is not used during the winter or the circuit is not emptied.

**Handle the unit** with the utmost care (see weight distribution table) to avoid damage.

## VISUAL INSPECTION

When the items are consigned by the carrier:

- make sure that the goods delivered correspond to the description on the delivery note, comparing this against the data on the packaging label.
- make sure the packaging and the unit are intact.

If damage or missing components are noted, indicate this on the delivery note. A formal complaint should be sent via fax or registered post to the After Sales Department within eight days from the date of receipt of the items.

## STORING THE UNITS

The units must be stored sheltered from direct sunlight, rain, wind or sand.

Avoid exposing the units to direct sunlight, as the pressure inside the refrigerant circuit may reach dangerous values and cause the activation of the safety valves, where fitted. The units cannot be stacked.

## HANDLING PACKAGED UNITS

The unit should always be handled by qualified personnel using equipment adequate for the weight of the unit, in compliance with the safety standards in force (and subsequent amendments).

### • Lifting by forklift (1)

Insert the forks under the long side of base, opening the forks as far as possible.

### • Lifting by crane (2)

Use slings with hooks suitable for the weight being lifted. Secure the hook to the lifting bracket fixed to the unit, use always four equal length slings, as shown in the figure, to ensure the weight is balanced.

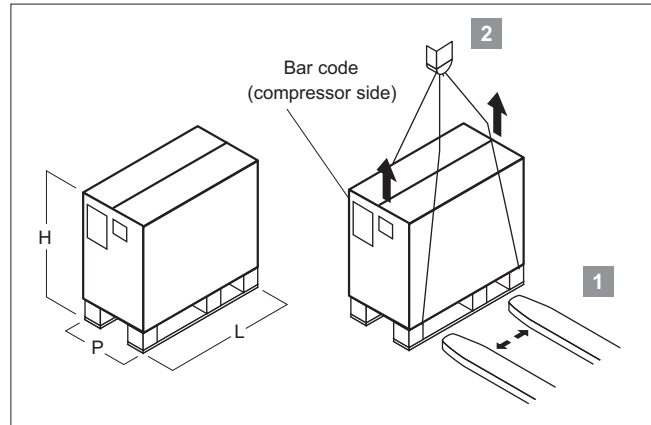

Dimensions		0011	0025	0031	0041	0051	0061	0091
Dimension L	mm	970	970	970	970	970	1600	1600
Dimension P	mm	525	525	525	525	525	610	610
Dimension H	mm	1450	1450	1450	1600	1600	1360	1850
Gross weight	Kg	165	170	175	190	200	275	360

## REMOVING THE PACKAGING

The packaging must be removed by the operator using suitable protective equipment (gloves, glasses, etc.).

Take special care not to damage the unit. Observe the local standards in force as regards disposal of the packaging, using specialist collection or recycling centres.

- Do not dispose of packaging materials in the environment or leave them within reach of children as they may represent a hazard.

Envelope A, located in the compressor compartment, contains:

- instruction manual;
- warranty certificate;
- CE declaration;
- list of the main components and sub-assemblies fitted on the product
- remote room control unit A5 (must be installed)
- DHW storage water temperature probe BT8
- outside air temperature probe BT11 (must be installed)
- probe BT9 only to be installed when supplementary source is available

Make sure the components listed above are not lost or misplaced.

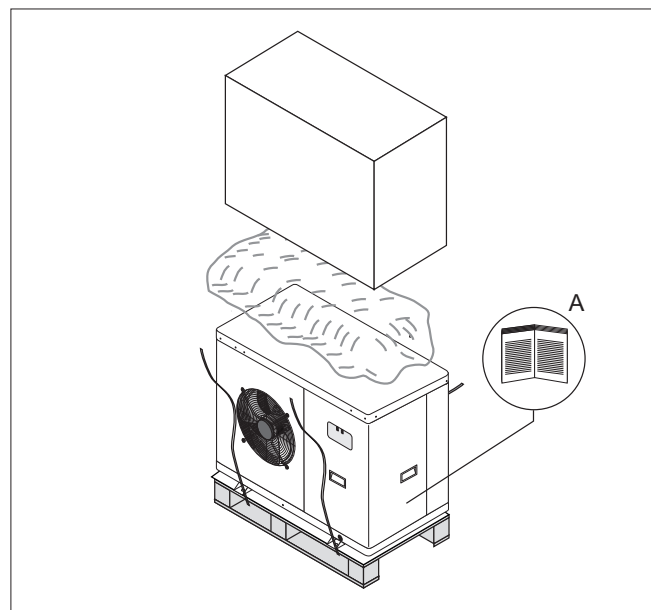

⚠ The instruction manual is an integral part of the unit and should therefore be read and kept carefully.

**HANDLING UNPACKAGED UNITS**

When the packaging has been removed:

- Remove the wooden base.
- Fit the vibration damping feet (accessories).
- Handle the unit using equipment that is suitable for its weight (forklift or crane), in compliance with the safety standards in force (and subsequent amendments).
- Do not drag the unit as the feet may be damaged or break.

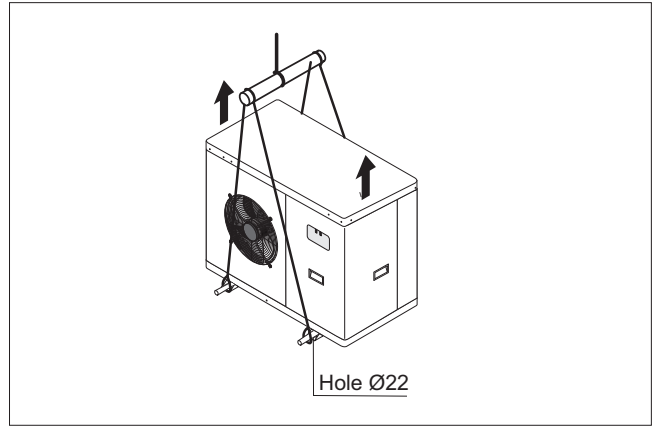

**UNIT IDENTIFICATION**

The heat pump can be identified from:

**PACKAGING LABEL**

Describes the product identification data

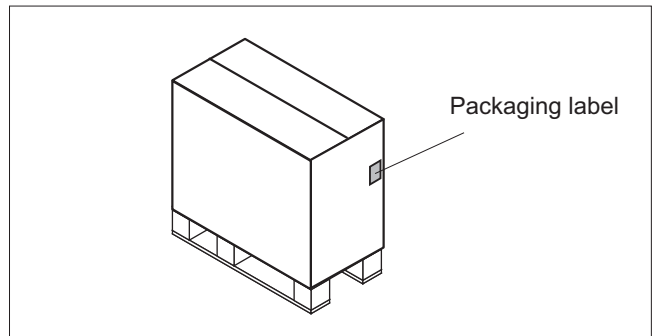

**RATING PLATE**

Describes the unit technical and performance specifications. Shows the serial number used to uniquely identify the unit. The serial number is also used to identify the unit's spare parts.

If service is required, the following information must be provided to the service centre:

Model, serial number, year of production.

⚠ Installation and maintenance operations are much more difficult if the identification plates or anything else needed to clearly identify the product are tampered with, removed or missing.

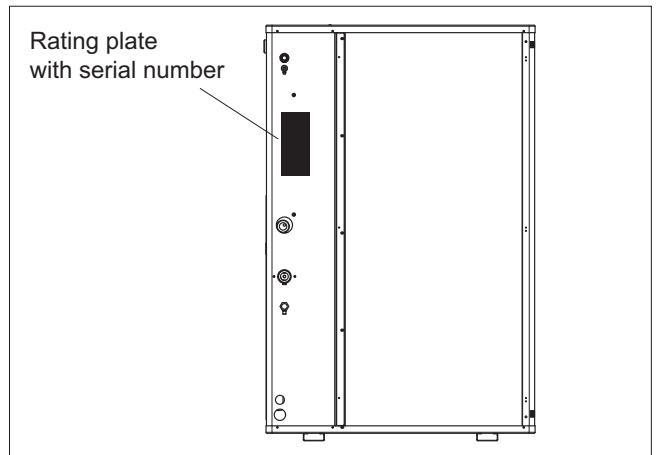

**NOMENCLATURE**

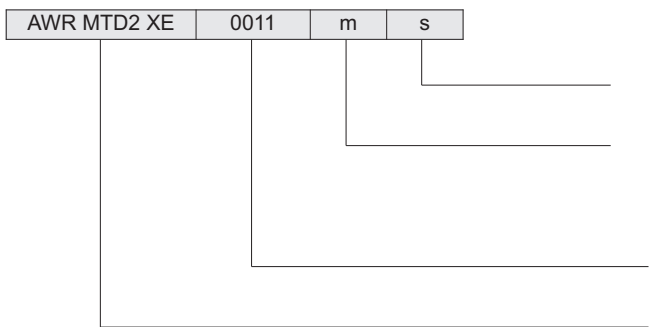

s = peak limiter

Power supply voltage:

m = 230V/50Hz/1ph

t = 400V/3N/50Hz

size

Model

These air cooled reverse-cycle chillers with axial-flow fans operate with R410A refrigerant fluid and are suitable for outdoor installation.

The units are CE marked, as established by the EU directives, including the latest amendments, and the corresponding approximated national legislation.

They are factory tested and on site installation is limited to water and electrical connections.

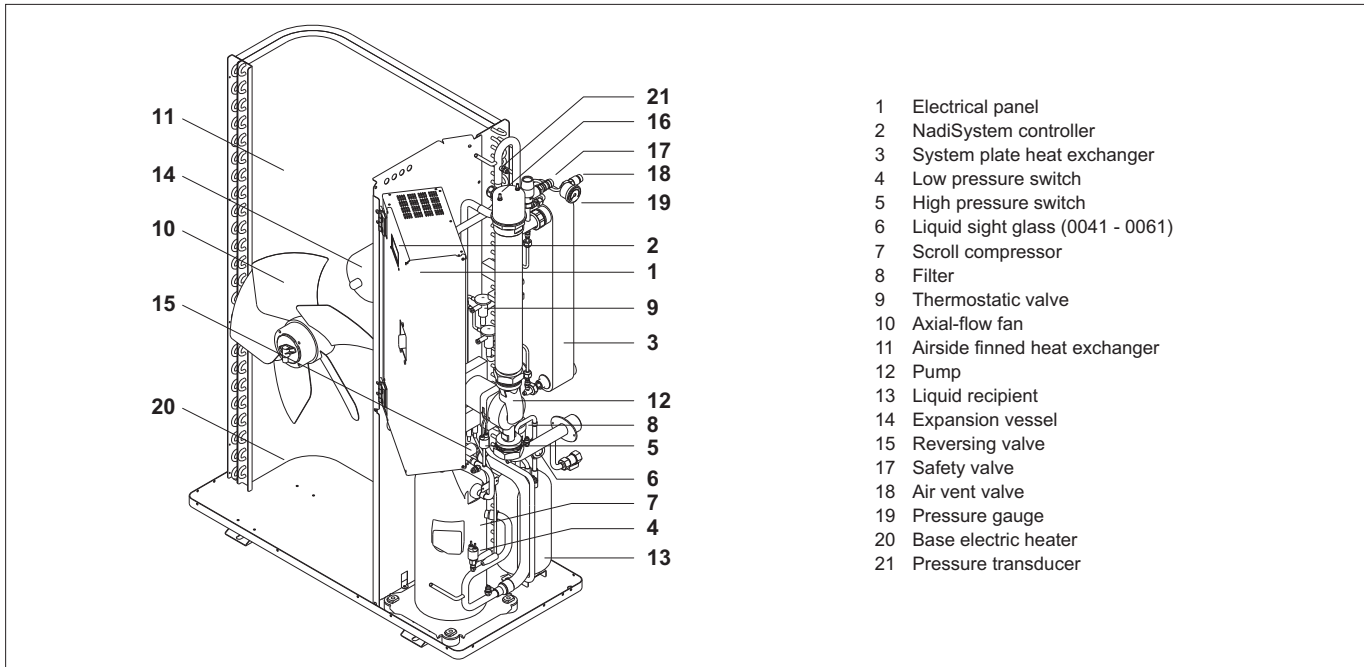

## VERSIONS AVAILABLE



### **AWR-MTD2-XE**

Reverse-cycle air/water heat pump with domestic hot water production. Built-in water pump assembly without electric heaters.

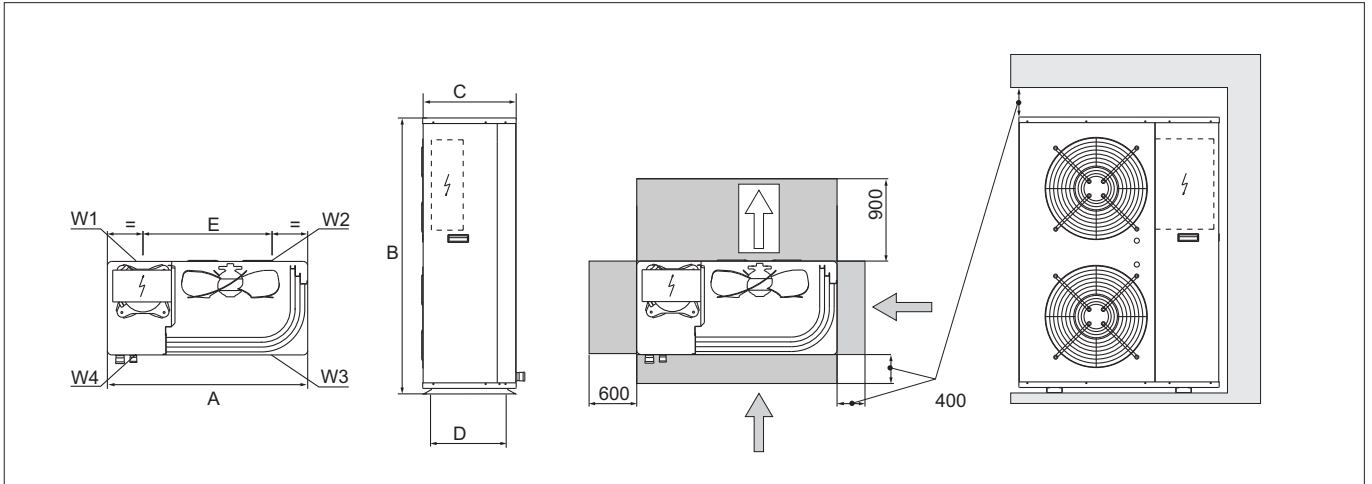

Dimensions		0011	0025	0031	0041	0051	0061	0091
A	mm	900	900	900	900	900	1550	1550
B	mm	1240	1240	1240	1390	1390	1200	1700
C	mm	420	420	420	420	420	450	450
D	mm	370	370	370	370	370	497	497
E	mm	580	580	580	580	580	1477	1477

Weight distribution		0011	0025	0031	0041	0051	0061	0091
W1 lato rear dx	kg	60	62	64	67	71	88	117
W2 lato rear sx	kg	17	18	20	23	24	39	54
W3 front sx	kg	17	18	18	22	22	36	51
W4 front dx	kg	51	52	53	58	63	87	113
tot	kg	145	150	155	170	180	250	335

INSTALLATION

CHOICE OF INSTALLATION SITE

Before installing the unit, agree with the customer the site where it will be installed, taking the following points into consideration:

- check that the support surface is adequate to support the weight of the unit;
- respect safety distances between the unit and other equipment or structures so that the fan air intake and outlet are not blocked in any way.

- Follow the instructions shown in the chapter on DIMENSIONED DRAWINGS to allow room for maintenance operations.

If installing multiple units the clearances must be doubled.

POSITIONING

- Install the vibration damping feet (accessories).
- Check the unit supports and weights before positioning
- Make sure that the unit is level, adjust the height of the support feet if necessary
- Use the flexible joints supplied for the water connections
- Make sure there is easy access to the water circuit and electrical parts
- For installation, if the site is exposed to strong winds, fix the unit adequately using tie rods if necessary.
- In heating mode the unit produces a significant quantity of condensate, which must be suitably drained. Condensate drainage must not cause problems to objects or people.
- If the outside air temperature is less than 0°C, the condensate may freeze; in these case fit a frost protection heater on the drain line.

- Consider the maximum height that may be reached by snow to avoid blocking the air intake or outlet (outdoor installation)
- Unit for outdoor installation

For correct operation of the unit, avoid the following:

- obstacles to air flow, such as leaves that may block the heat exchange coil
- strong winds that stop or reinforce air flow
- sources of heat too close to the unit
- air recirculation between intake and outlet
- poor air change
- stratification of air

**Warnings**

- The choice and installation of components is the responsibility of the installer who should follow good working practice and current legislation.

Before connecting the pipes make sure that these:

- do not contain stones, sand, rust, scale or any foreign objects that may damage the system.
- wash the system with clean water

**Water connection dimensions**

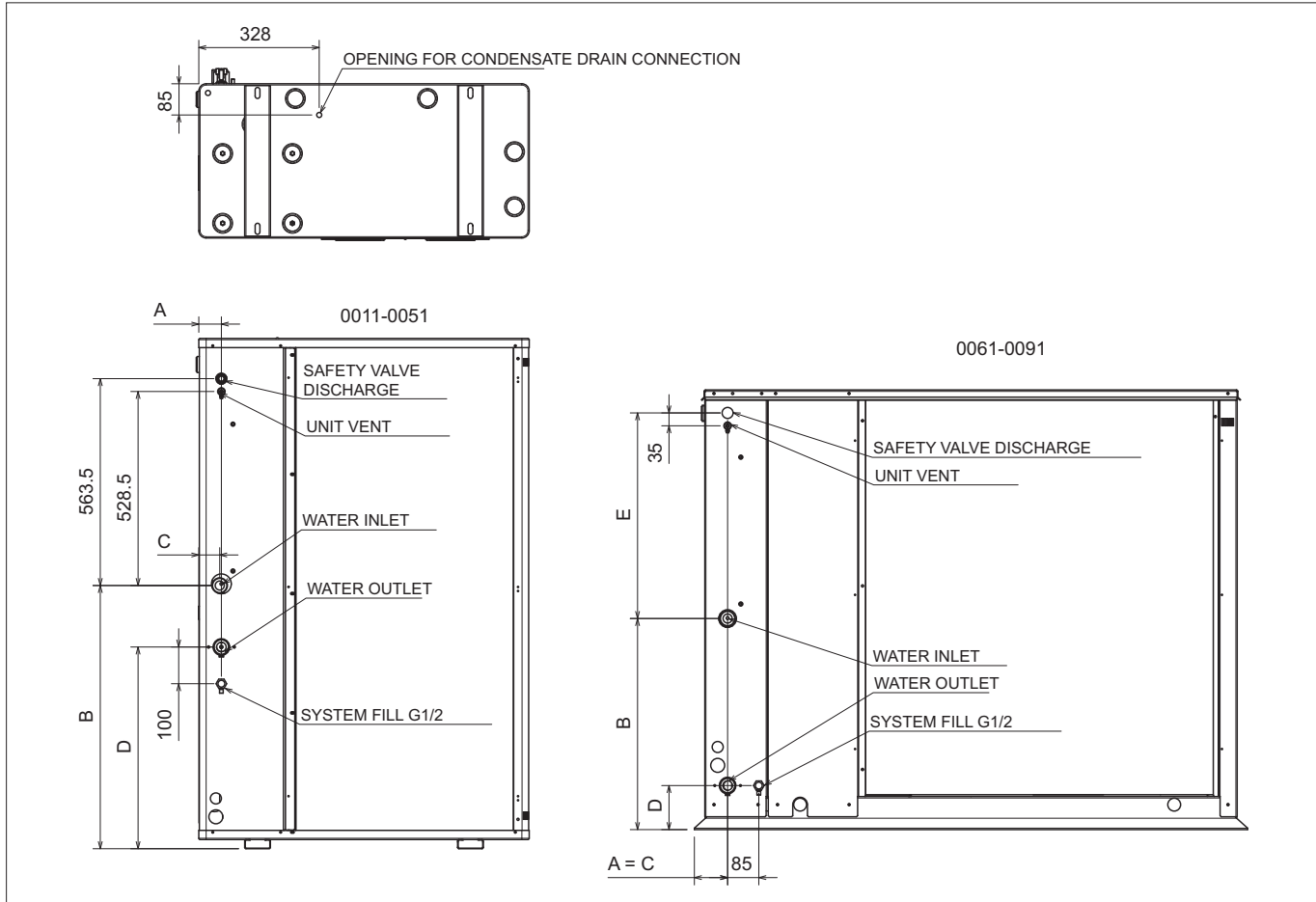

Dimensions		0011	0025	0031	0041	0051	0061	0091
A	mm	61,5	61,5	61,5	61,5	61,5	90,5	90,5
B	mm	617	617	617	717,5	717,5	575	770
C	mm	57	57	57	57	57	90,5	90,5
D	mm	454,5	454,5	454,5	549,5	549,5	120	120
E	mm	-	-	-	-	-	560	551
Water in fittings	Ø	1"	1"	1"	1" 1/4	1" 1/4	1" 1/4	1" 1/4
Water out fittings	Ø	1"	1"	1"	1" 1/4	1" 1/4	1" 1/4	1" 1/4

**Components**

The following components should be installed for correct installation of the unit:

1. Two pressure gauges with a suitable scale (inlet and outlet);
2. Two vibration damper joints (inlet and outlet).
3. Shut-off valves at the inlet and outlet.
4. A flow switch at the unit outlet on the system circuit (compulsory). The flow switch must be calibrated by the installer to a value equal to 70% of rated flow.
5. Two thermometers (inlet and outlet);
6. An inlet filter (compulsory) as close as possible to the unit and positioned to allow easy access for scheduled maintenance (both on the system circuit and domestic hot water circuit).

7. All the pipes must be insulated with suitable material to prevent the formation of condensate and heat loss. The insulating material must be a vapour barrier. Make sure that the control and shut off devices protrude from the insulation.
8. At the lowest points in the system, install drain valves for easy emptying.
9. At the highest points in the system, install automatic or manual air vent valves.
10. The unit is fitted as standard with an expansion vessel; make sure this is correctly sized for the water content of the system and the expected operating temperature, otherwise install an additional expansion vessel.



11. The connection piping should be supported in such a way as to avoid it weighing on the unit.

⚠ Failure to install the flow switches will mean the heat exchangers are not protected in the event of no flow of liquid. The Manufacturer cannot be held liable for any damage to the unit and/or the system following the failure to install these devices or the filter.

⚠ The correct operation of the components that help ensure the safety of the appliance and the system should be checked regularly:

- make sure the filters are clean
- check operation of the flow switches installed.

- Make sure that the frost protection heaters on the heat exchanger are powered when the unit is OFF

Water flow to the heat pump must conform to the values shown in the section on "General Technical Data". The flow of water must be maintained constant during operation. The water content of the unit must be such as to avoid disturbing operation of the refrigerant circuits.

**Risk of freezing**

The unit must be prevented from freezing at outside air temperatures around 0°C.

The following are recommended:

- use suitable percentages of antifreeze (see "Ethylene glycol solutions")
- protect the piping with heating sheaths,
- empty the system, making sure no water remains at the lowest points in the circuit or there are closed valves where water may stagnate.

It is recommended to use non-toxic food grade antifreeze, compliant with the standards in force in the countries where the unit is used, if domestic hot water production is also featured.

The antifreeze used must be corrosion inhibited and compatible with the water circuit components.

**Ethylene glycol solutions**

Water and ethylene glycol solutions used as a heat carrier in the place of water reduce the performance of the unit.

Multiply the performance figures by the values given in the following table.

⚠ The heat pumps must be fitted with a filling/top-up system connected to the return line and a drain valve in the lowest part of the system.

**Systems containing antifreeze** or covered by specific legislation must be fitted with low-loss headers.

Freezing point (°C)						
	0	-5	-10	-15	-20	-25
Percentage of ethylene glycol by weight						
	0	12%	20%	28%	35%	40%
cPf	1	0,985	0,98	0,974	0,97	0,965
cQ	1	1,02	1,04	1,075	1,11	1,14
cdp	1	1,07	1,11	1,18	1,22	1,24

cPf: cooling capacity correction factor  
 cQ: flow rate correction factor  
 cdp: pressure drop correction factor

**Water quality**

The water used in the system and domestic hot water circuits must comply with the following characteristics:

PH	6-8
Electrical conductivity	less than 200 mV/cm (25°C)
Chlorine ions	less than 50 ppm
Sulphuric acid ions	less than 50 ppm
Total iron	less than 0.3 ppm
Alkalinity M	less than 50 ppm
Total hardness	less than 50 ppm
Sulphur ions	none
Ammonia ions	none
Silicon ions	less than 30 ppm

**Fouling factors**

The performance data given refer to conditions with clean evaporator plates (fouling factor = 1).

For different fouling factors, multiply the figures in the performance tables by the coefficient given in the following table.

Fouling factors (m <sup>2</sup> °C/W)	Evaporator		
	f1	fk1	fx1
4,4 x 10 <sup>-5</sup>	-	-	-
0,86 x 10 <sup>-4</sup>	0,96	0,99	0,99
1,72 x 10 <sup>-4</sup>	0,93	0,98	0,98

f1: capacity correction factor  
 fk1: compressor power input correction factor  
 fx1: total power input correction factor

**Water content in the system**

Size		0011	0025	0031	0041	0051	0061	0091
Minimum water content	l	24	31,5	40	46	65	74	110

**Expansion vessel size**

Size		0011	0025	0031	0041	0051	0061	0091
Expansion vessel	l	2	2	2	2	2	4	4

**Safety valve calibration**

Size		0011	0025	0031	0041	0051	0061	0091
Safety valve	bars	6	6	6	6	6	6	6

**Utility water circuit connection diagram**

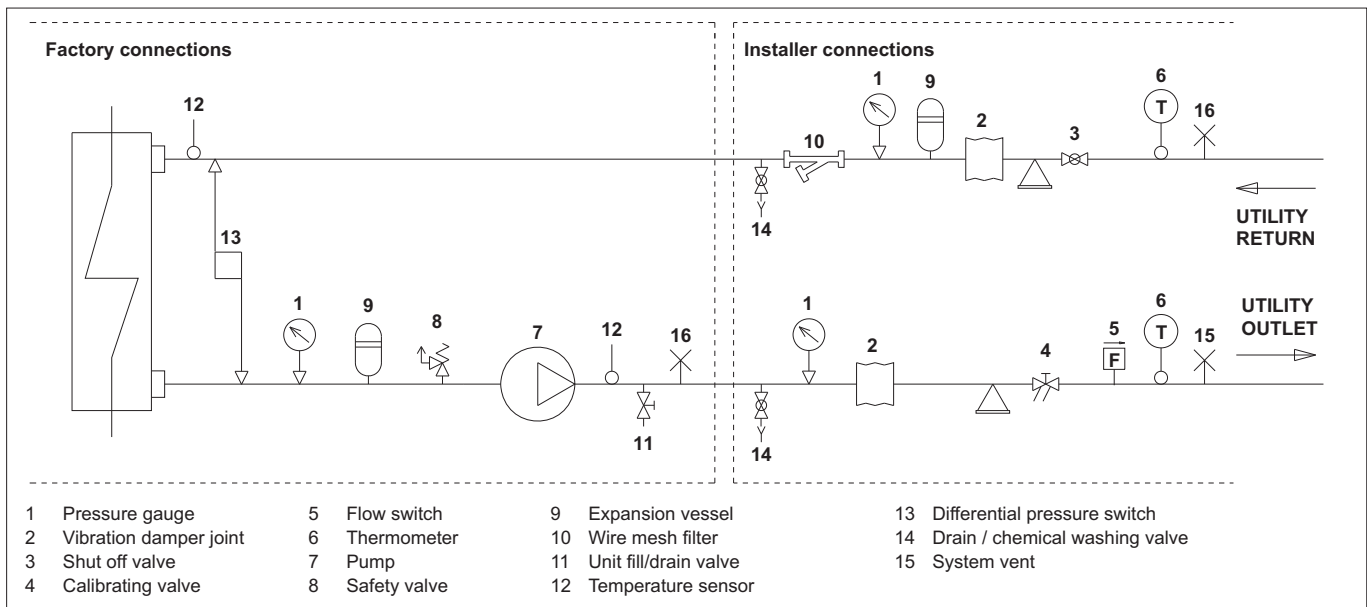

**Condensate drain**

In heating mode the unit produces a significant quantity of condensate, which must be suitably drained.

Proceed as follows:

- Connect the unit condensate drain
- Make sure the drain hose has a incline of at least 2 cm/m, without obstructions or choking.
- Connect the condensate drain hose to a rainwater drain. Do not connect to the sewage system as odours may be sucked up if the water in the drain trap evaporates.
- After connecting, check correct drainage of the condensate by pouring water into the pan.

- If necessary, suitably insulate the condensate drain hose.
- Condensate drainage must not cause problems to objects or people.
- If the outside air temperature is less than 0°C, the condensate may freeze.

The unit comes with frost protection for the condensate collection basin inside the unit.

Use hot wires on the condensate drain hose downstream of the unit to protect against frost.

**FILLING THE SYSTEM**

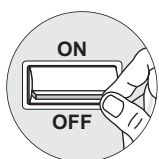

- Before starting to fill, place the unit mains switch QF1 in the OFF position.
- Before filling, check that the system drain valve is closed.
- Open all system and terminal air vents.
- Open system shut off valves.
- Start filling by slowly opening the system water fill valve outside the unit.
- When water begins to leak out of the terminal air vent valves,

close them and continue filling until the pressure gauge indicates a pressure of 1.5 bar.

**⚠ The system must be filled** to a pressure of between 1 and 2 bars.

**It is recommended** that this operation be repeated after the unit has been operating for a number of hours. The pressure in the system should be checked regularly and if it drops below 1 bar, the water content should be topped-up.

**Check** the tightness of the joints.

The heat pumps must be installed downstream of a main switch (QF1, see wiring diagram), as required by the standards in force in the country where the unit is installed. Connection to the mains power supply and the connection of the flow switch to the corresponding terminals must be performed by authorised personnel in compliance with the standards in force.

For all electrical work, refer to the electrical wiring diagrams in this manual.

It is also recommended to check that:

- The characteristics of the mains electricity supply are adequate for the power ratings indicated in the electrical specifications below, also bearing in mind the possible use of other equipment at the same time.

**⚠ Power to the unit** must be turned on only after installation work (plumbing and electrical) has been completed.

**All electrical connections** must be carried out by qualified personnel in accordance with legislation in force in the country concerned

**Respect instructions** for connecting phase, neutral and earth conductors..

The power line should be fitted upstream with a suitable device to protect against short-circuits and leakage to earth, isolating the installation from other equipment.

**⚠ Voltage** must be within a tolerance of  $\pm 10\%$  of the rated power supply voltage for the unit (for three phase units, the unbalance between the phases must not exceed 3%). If these parameters are not respected, contact the electricity supply company.

**For electrical connections**, use double insulation cable in conformity with legislation in force in the country concerned..

**⚠ A thermal overload switch and a lockable mains disconnect switch, in compliance with the CEI-EN standards (contact opening of at least 3mm), with adequate switching and residual current protection capacity based on the electrical data table shown below, must be installed as near as possible to the appliance.**

**⚠ An efficient earth connection is obligatory.**

The manufacturer cannot be held liable for any damage caused by the failure to correctly earth the unit.

**In the case of three phase units**, ensure the phases are connected correctly.

**⊘ Do not use** water pipes to earth the unit.

### Electrical data at maximum conditions allowed (full load)

Size	Power supply (V-Ph-Hz)	Maximum values							Fuses (5x20T 250V)		
		Heater		Power consumption without heater		Total power consumption		L.R.A.	FU1	FU5	FU6
		P MAX [kW]	I MAX [A]	P MAX TOT [kW]	I MAX TOT [A]	F.L.I. [kW]	F.L.A. [A]	[A]	[A]	[A]	
0011ms	230-1N-50	-	-	-	-	2,82	13,5	27	1,6	4	1,25
0025ms	230-1N-50	-	-	-	-	3,56	16,7	30	1,6	4	1,25
0031ms	230-1N-50	-	-	-	-	5,11	23,6	45	1,6	4	1,25
0041ms	230-1N-50	-	-	-	-	6,15	30,1	45	1,6	4	1,25
0031t	400-3N-50	-	-	-	-	4,76	10,0	48	1,6	4	1,25
0041t	400-3N-50	-	-	-	-	6,38	12,4	64	1,6	4	1,25
0051t	400-3N-50	-	-	-	-	6,43	12,7	64	1,6	4	1,25
0061t	400-3N-50	-	-	-	-	7,77	14,8	75	1,6	4	1,25
0091t	400-3N-50	-	-	-	-	10,86	24,6	111	2	4	1,25

F.L.I. Maximum power input

F.L.A. Maximum current input

L.R.A. Start-up current

Maximum values for sizing the protection switches and power supply cables.

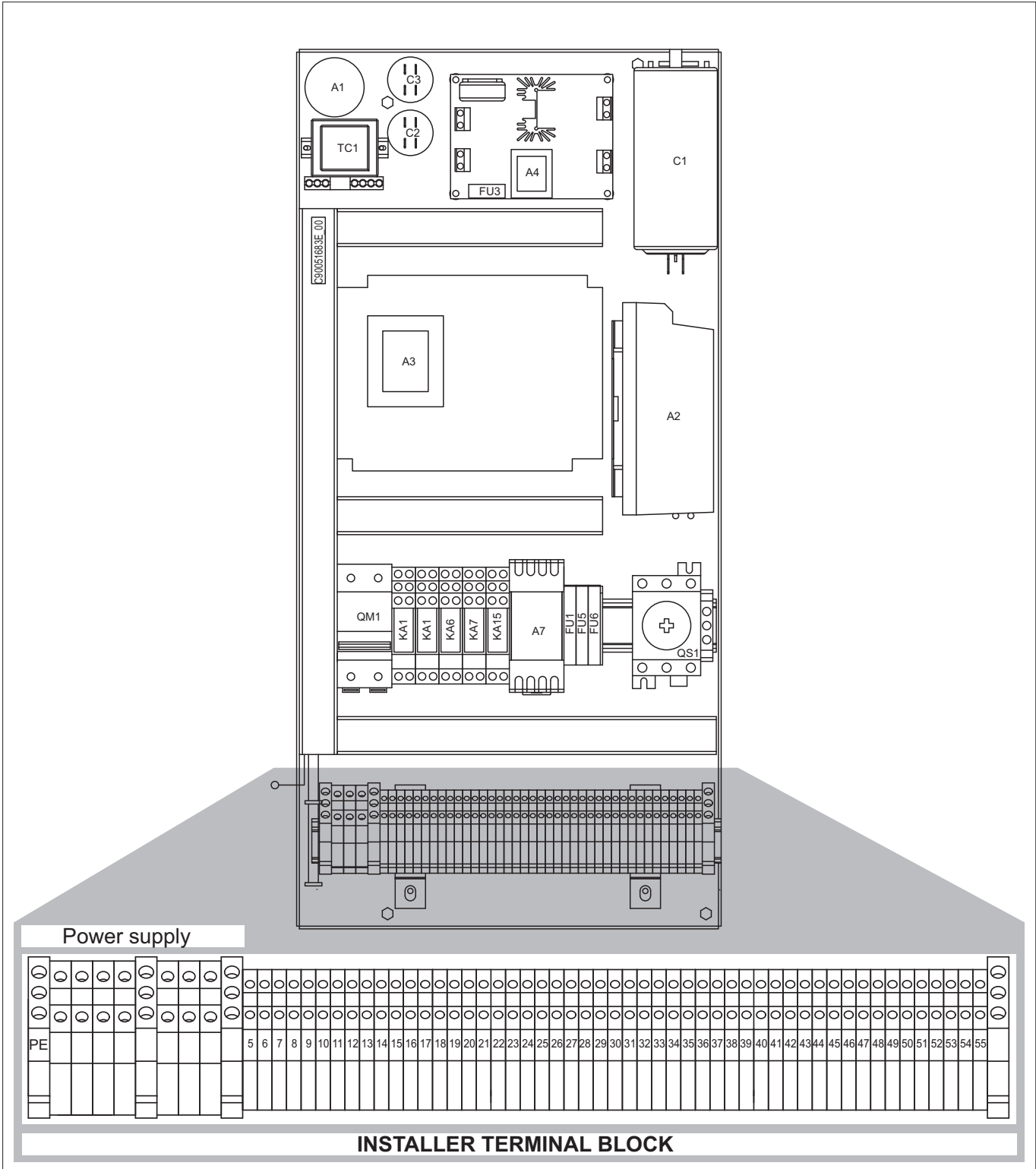

- Before connecting the unit to the power supply, make sure that switch QF1 is open, suitably padlocked and marked.
- Remove the inspection panel by unscrewing the screws.

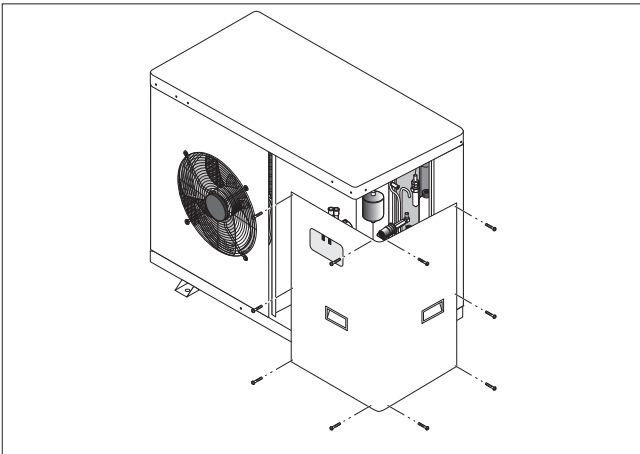

- Use cable gland **A** for the main electrical power cable and cable gland **B** for other external cables to be connected by the installer.

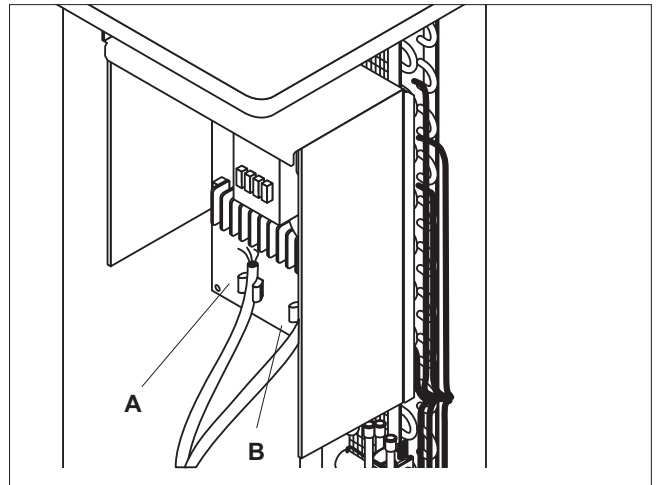

- Identify the terminals used for electrical connections on the layout drawing shown in this manual.
- Make the connections as shown in the wiring diagram provided in this manual.
- The figures show the power supply connection terminals for 230V and 400V.
- Replace the covers on the electrical panel and the closing panel.
- Make sure that all the covers removed to make the electrical connections have been replaced before powering up the unit.
- Position the main switch QF1 (outside the unit) in the "ON" position.
- Once the remote terminal has been switched on, "OFF" and "init" are displayed.
- The room unit is ready to use after a few seconds, when "init" is shown and the clock is displayed

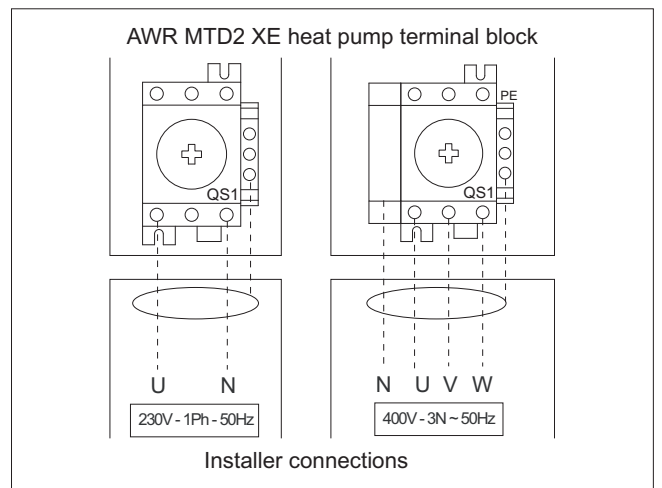

Power supply	230V	400V
Number of power wires	2 + PE	4 + PE
Power wire size*	6 mmq	6 mmq

\* Compliant with standards in force in the place where the unit is installed

**Outside air probe (BT11) connection**

The outside air probe allows the system water temperature set point to be compensated during heating or cooling operation.

**Installation instructions**

The outside air probe must be installed:

- outside of the home
- not in direct sunlight, away from flue gas discharges, air outlets, or doors and windows.
- on a perimeter wall facing north/north-west
- at a minimum height of 2.5 metres above the ground or at most half way up the house.

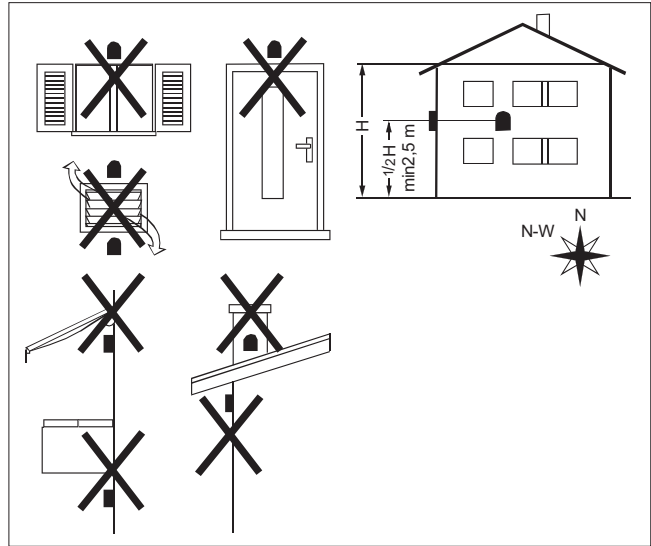

**Mounting method:**

- Open the cover of the sensor.
- Attach a probe to the wall and the correct position as described above.
- For the electrical connections see "Connection diagram".
- Re-place the cover of the sensor.

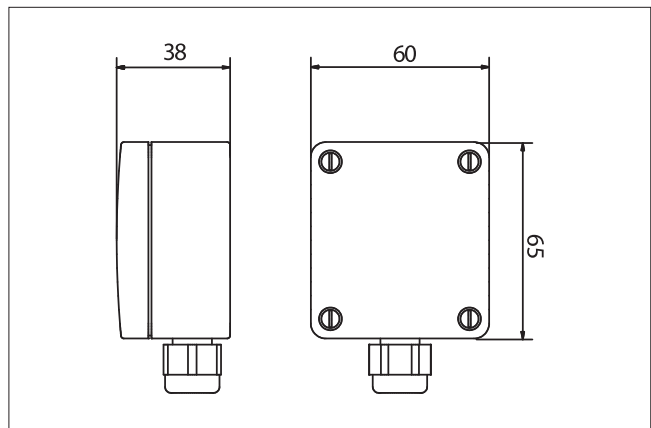

TECHNICAL DATA	
Sensing element	NTC 10Kohm ± 1% (25°C)
Degree of protection	IP65
Perm. ambient / carriage temperature	-50°C...+100°C
Measuring range	-50°C...+100°C
Materials	PA 15% GK, Colour RAL 9010

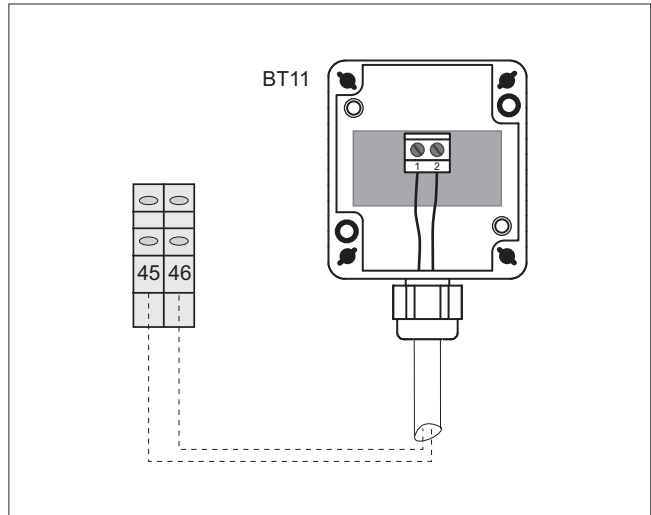

**A5 room controller connection**

**Installation instructions**

The room controller must be installed in the best reference position for temperature control.

Position the room controller as follows:

- around 1.5 metres from the floor, in a part of the room that allows the sensor to accurately measure the room temperature;
- away from cold air flows, sunlight or other sources of heat.
- leave enough space above the room controller to allow assembly and removal where necessary.
- If the room controller is removed from its base, it disconnects from the power supply and consequently is no longer operating.

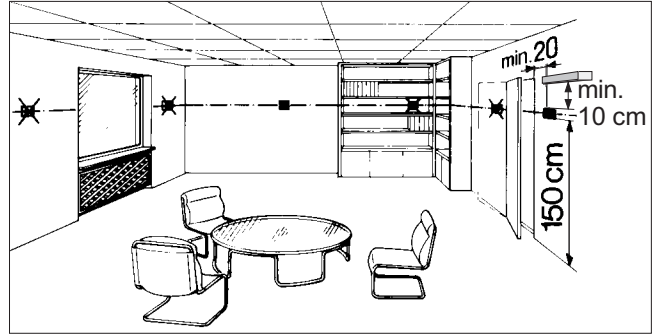

**Installation procedure**

**Assembly**

- Separate the front from the rear of the terminal using a screwdriver r (1)
- Disconnect the 4-pin connector from the front part (2)
- Remove the cover A1, unscrewing the screw A2 (3).
- Fix the controller support to the wall using the holes A3 (4). Support hole size and spacing in figure (5).
- Make the electrical connections as shown in the figure (6), also see the wiring diagram.

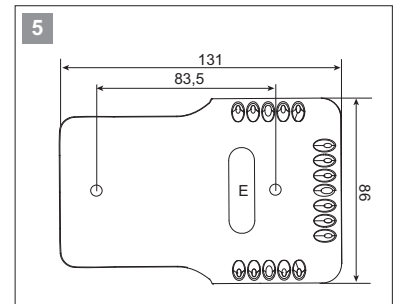
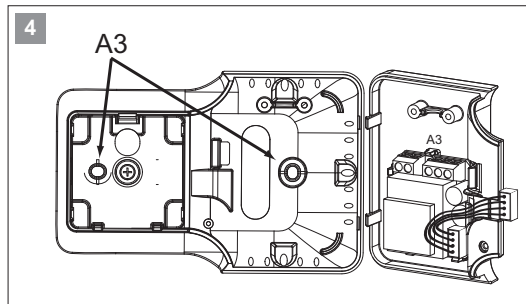
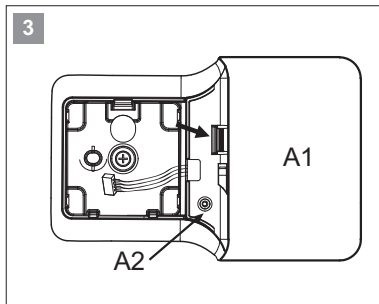
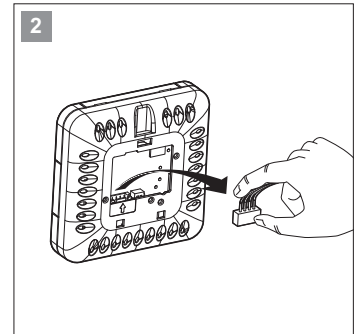
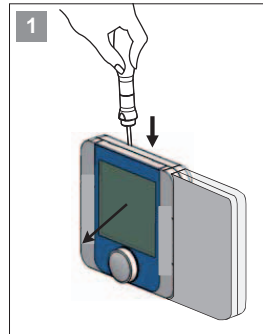

**6**

**A5 room controller terminal block**

**Installer terminal block**

Number of wires	5 shielded
Power supply wire size	0.5 mm <sup>2</sup>
Maximum distance	500 m

- Close the cover A1 and secure it with the screw A2
- Plug in the 4-pin connector, figure (7)
- Replace the terminal, starting with the lower tabs, applying a hinge movement. Make sure that the electrical wires are inside to ensure correct fastening (click on).
- Dimensions of A5 room controller figure (8).

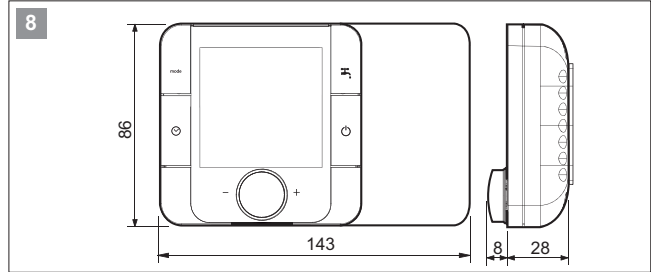
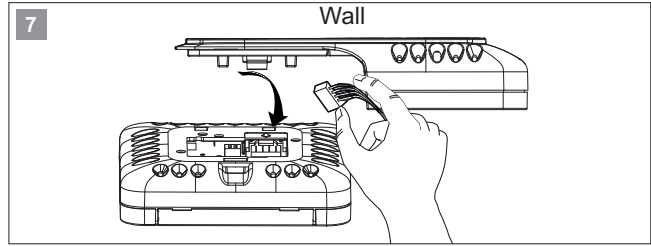

**YV5 3-way valve for domestic hot water production**

The 3-way valve installed outside of the unit deviates the flow of hot water produced by the unit to the DHW storage tank.

During domestic hot water production, the cooling/heating demand is not satisfied.

Wire the three-way valve supplied as an accessory by Manufacturer following the instructions shown in the figure.

The valve is also fitted with a limit switch. The limit switch contact is either closed or open based on the position of the valve.

Limit switch (red and green wires):

Auxiliary contact closed = Valve open

Auxiliary contact open = Valve closed

If not supplied by Manufacturer, the 3-way valve for domestic hot water production should have the following characteristics:

- Voltage 230V AC, 50/60 Hz
- Opening/closing time 10s.
- Delta P 500 kPa
- Fluid temperature 0°C to 90°C

Use three-way valves with pressure drop below 20 kPa.

For further details see the chapter “Operating characteristics”.

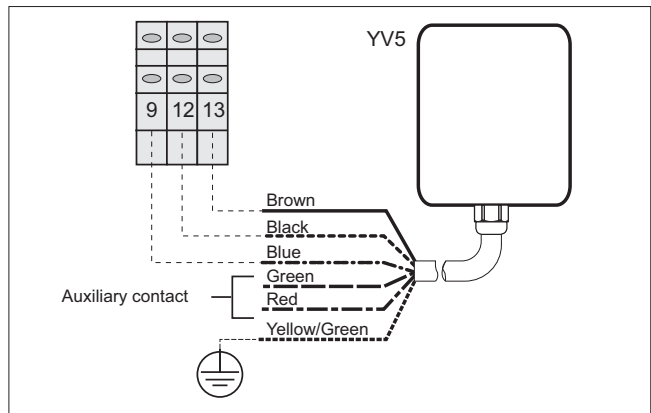

If three-way valves with a travel time greater than 10 seconds are used, modify the setting of parameter 0231

Description	Menu	Parameter no.	Default	Value to be set	UOM
Three-way valve travel time for domestic hot water production	Mn02	0231	12	Set the travel time for valves not supplied by the heat pump manufacturer	sec.

**Optional connection**

**KM2 System outlet electric heater**

An electric heater installed at the outlet can be activated as a supplementary heater for the system.

**Solution 1**

System with heat pump and electric heater with storage tank.

Position probe BT9 in the storage tank.

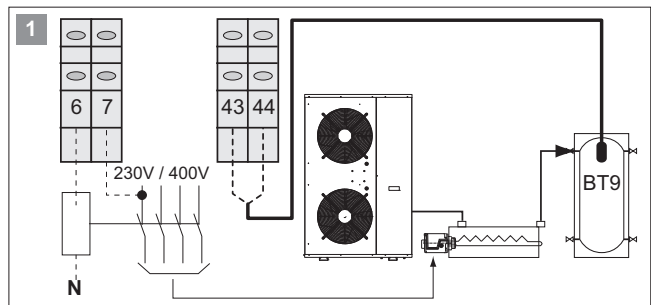



**Solution 2**

System with heat pump and outlet electric heater WITHOUT storage tank.

Position probe BT9 on the system outlet pipe.

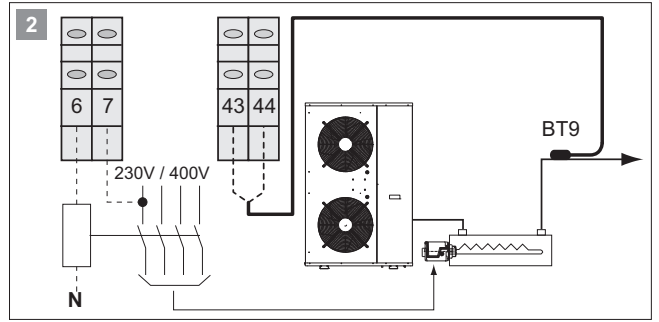

**Outlet electric heater control**

**A) REPLACEMENT:** The electric heater is enabled when the outside temperature is less than the value of parameter 0304 and the compressor is off, figure 3. To enable heater activation in REPLACEMENT mode set parameter 0303 = 1 and 010G = 1.

Electric heater operation reflects the trend in water outlet temperature, as shown on the graph in figure 4.

If the heat pump shuts down due to an alarm, the electric heater is activated automatically regardless of the outside air temperature.

In REPLACEMENT mode the electric heater activation delay time is ignored, and the device is activated immediately if necessary.

**B) SUPPLEMENTARY:** the electric heater operates in supplementary heating mode, together with the compressor, to satisfy the heating load.

**Supplementary heating for low outside air temperature**

The electric heater is enabled only when the outside temperature is less than the value of parameter 0304, figure 3. To enable supplementary heating for low outside air temperature set parameter 0303 = 1 and 010G = 0

Electric heater operation reflects the trend in water outlet temperature, as shown on the graph in figure 4.

**Outlet electric heater operating parameters in REPLACEMENT mode**

Description	Menu	Parameter no	Value to be set	UOM
Activation electrical heater 0 = Electrical Heater not enabled 1 = Electrical Heater enabled	Mn03	0300	1*	
Type of outlet electric heater operation 0 = Supplementary 1 = Replacement	Mn01	010G	1	
Enable boiler 0 = Boiler not enabled 1 = Boiler enabled	Mn03	0301	0*	
Activation with low outside air temperature 0 = Function not enabled 1 = Function enabled	Mn03	0303	1	
Outside air temperature to enable electric heater	Mn03	0304	Example -5°C	°C
Integration time to activate outlet electric heaters	Mn06	0617	600	°C*sec

**Set the parameters following the sequence described in the table**

**Outlet electric heater operating parameters in SUPPLEMENTARY mode for OUTSIDE AIR TEMP.**

Description	Menu	Parameter no	Value to be set	UOM
Activation electrical heater 0 = Electrical Heater not enabled 1 = Electrical Heater enabled	Mn01	0300	1*	
Type of outlet electric heater operation 0 = Supplementary 1 = Replacement	Mn03	010G	0	
Enable boiler 0 = Boiler not enabled 1 = Boiler enabled	Mn03	0301	0*	
Activation with low outside air temperature 0 = Function not enabled 1 = Function enabled	Mn03	0303	1	
Outside air temperature to enable electric heater	Mn03	0304	Example -5°C	°C
Minimum outside air temperature for heat pump operation (make sure the value set is the same as shown in the table)	Mn03	0311	-15	°C
Electric heater delay time (allows the heat pump to reach steady operation and thus avoid activating the heater when not needed)	Mn06	0616	60	min.
Integration time to activate outlet electric heaters	Mn06	0617	600	°C*sec

**Set the parameters following the sequence described in the table**

**Supplementary heating always enabled**

Supplementary heating with the electric heater is enabled for all outside air temperatures.

To enable heating at all times set parameter 0303 = 0 and 010G = 0

Electric heater operation reflects the trend in water outlet temperature, as shown on the graph in figure 4.

**Outlet electric heater operating parameters in SUPPLEMENTARY mode when always ENABLED**

Description	Menu	Parameter no	Value to be set	UOM
Activation electrical heater 0 = Electrical Heater not enabled 1 = Electrical Heater enabled	Mn03	0300	1*	
Type of outlet electric heater operation 0 = Supplementary 1 = Replacement	Mn01	010G	0	
Enable boiler 0 = Boiler not enabled 1 = Boiler enabled	Mn03	0301	0*	
Activation with low outside air temperature 0 = Function not enabled 1 = Function enabled	Mn03	0303	0	
Minimum outside air temperature for heat pump operation (make sure the value set is the same as shown in the table)	Mn03	0311	-15	°C
Electric heater delay time (allows the heat pump to reach steady operation and thus avoid activating the heater when not needed)	Mn06	0616	60	min.
Integration time to activate outlet electric heaters	Mn06	0617	600	°C*sec

**Set the parameters following the sequence described in the table**

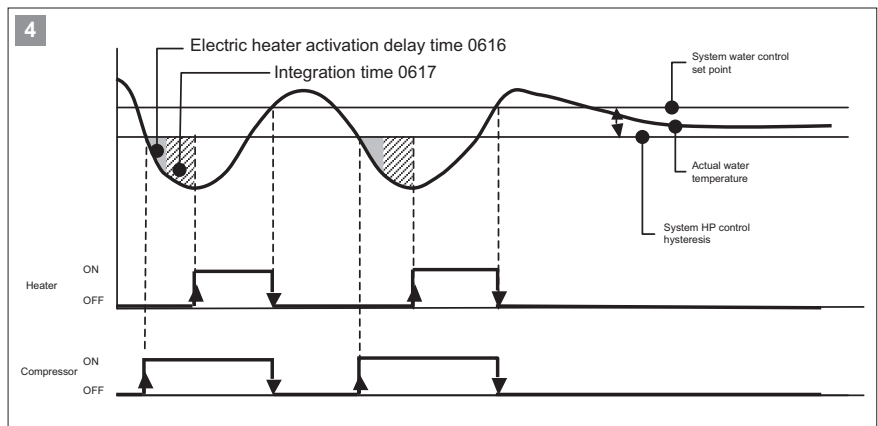
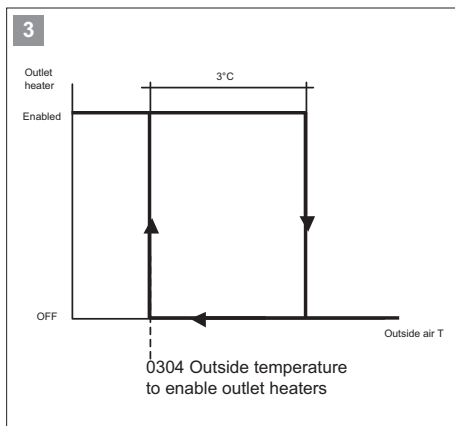

Once the heater is enabled, supplementary heating is activated when the integration time set for parameter 0617 is reached and the delay time 0616 has elapsed. The delay time is ignored when the unit is first started.

Example:  
 Value 0617 = 600°C\*sec  
 Outlet temperature set point= 50°C  
 Actual temperature = 40°C

$$(50 - 40) \times 60 \text{ sec} = 600^\circ\text{Csec.} \text{ ----> Electric heater ON}$$

Low values of 0617 mean frequent activation of the heater.  
 Too high values of 0617 mean long delays in activating the heater

**KM2 Boiler**

A boiler can be used as a supplementary or replacement heat source for the system.

**Solution 1**

System with heat pump and boiler with storage tank.

**Solution 2**

System with heat pump and boiler without storage tank.

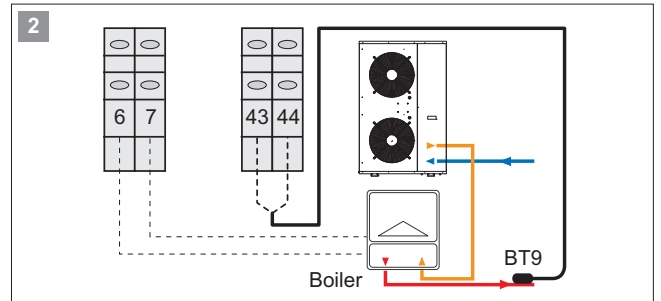
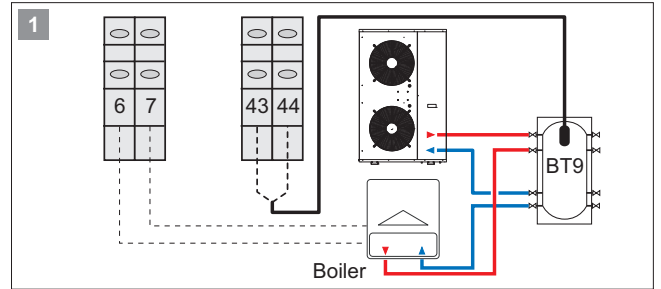

**Boiler control**

**A) REPLACEMENT:** the boiler is only enabled if the outside air temperature is less than the value of parameter 0307 and the compressor is off, figure 3.

To enable boiler activation in REPLACEMENT mode set parameter 0306=1 and 010H = 1

Boiler operation reflects the trend in water temperature, as shown on the graph in figure 4.

If the heat pump shuts down due to an alarm the boiler is activated automatically regardless of the outside air temperature.

In REPLACEMENT mode the activation delay time is ignored, and the boiler is activated immediately if necessary.

**B) SUPPLEMENTARY:** the boiler operates in supplementary heating mode, together with the compressor, to satisfy the heating load.

Supplementary heating for low outside air temperature  
The boiler is enabled only when the outside air temperature is less than the value of parameter 0307, figure 3.

To enable the supplementary heating for outside air temperature set parameter 0306 = 1 and 010H = 0

Boiler operation reflects the trend in water temperature, as shown on the graph in figure 4.

**Boiler operating parameters in REPLACEMENT mode**

Description	Menu	Parameter no.	Value to be set	UOM
Enable electric heater 0 = Heater not enabled 1 = Heater enabled	Mn03	0300	0	
Activation Boiler 0 = Boiler not enabled 1 = Boiler enabled	Mn03	0301	1	
Type of boiler operation 0 = Supplementary 1 = Replacemen	Mn01	010H	1	
Activation with low outside air temperature 0 = Function not enabled 1 = Function enabled	Mn03	0306	1	
Outside air temperature to enable boiler	Mn03	0307	Example -5°C	°C
Integration time to activate boiler	Mn06	0619	600	°C*sec

Set the parameters following the sequence described in the table

**Boiler operating parameters in SUPPLEMENTARY mode for outside temperature**

Description	Menu	Parameter no.	Value to be set	UOM
Enable electric heater 0 = Heater not enabled 1 = Heater enabled	Mn03	0300	0	
Activation Boiler 0 = Boiler not enabled 1 = Boiler enabled	Mn03	0301	1	
Type of boiler operation 0 = Supplementary 1 = Replacemen	Mn01	010H	0	
Activation with low outside air temperature 0 = Function not enabled 1 = Function enabled	Mn03	0306	1	
Outside air temperature to enable boiler	Mn03	0307	Example -5°C	°C
Minimum outside air temperature for heat pump operation (make sure the value set is the same as shown in the table)	Mn03	0311	-15	°C
Boiler activation delay time (allows the heat pump to reach steady operation and thus avoid activating the boiler when not needed)	Mn06	0618	60	min.
Integration time to activate boiler	Mn06	0619	600	°C*sec

Set the parameters following the sequence described in the table

**Supplementary heating always enabled**

Supplementary heating by boiler is enabled for all outside air temperatures.

To enable heating at all times set parameter 0306 = 0 and 010H = 0

Boiler operation reflects the trend in water temperature, as shown on the graph in figure 4.

**Boiler operating parameters in SUPPLEMENTARY mode when always ENABLED**

Description	Menu	Parameter no.	Value to be set	UOM
Enable electric heater 0 = Heater not enabled 1 = Heater enabled	Mn03	0300	0	
Activation Boiler 0 = Boiler not enabled 1 = Boiler enabled	Mn03	0301	1	
Type of boiler operation 0 = Supplementary 1 = Replacement	Mn01	010H	0	
Activation with low outside air temperature 0 = Function not enabled 1 = Function enabled	Mn03	0306	0	
Outside air temperature to enable boiler	Mn03	0307	Example -5°C	°C
Minimum outside air temperature for heat pump operation (make sure the value set is the same as shown in the table)	Mn03	0311	-15	°C
Boiler activation delay time (allows the heat pump to reach steady operation and thus avoid activating the boiler when not needed)	Mn06	0618	60	min.
Integration time to activate boiler	Mn06	0619	600	°C*sec

Set the parameters following the sequence described in the table

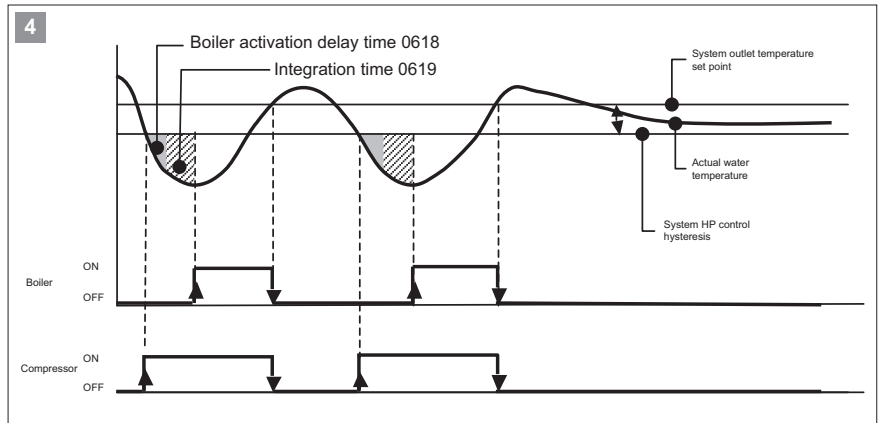
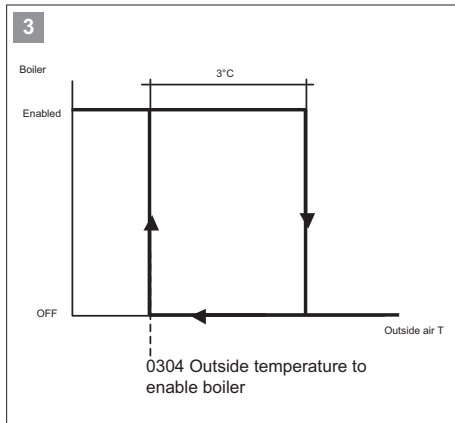

Once the boiler has been enabled, supplementary heating is activated when the integration time set for parameter 0619 is reached and the delay time 0618 has elapsed. The delay time is ignored when the unit is first started.

Example:  
 Value 0619 = 600°C\*sec  
 Outlet temperature set point= 50°C  
 Actual temperature = 40°C

$$(50 - 40) \times 60 \text{ sec} = 600^\circ\text{Csec.} \text{ ----> Boiler ON}$$

Low values of 0619 mean frequent activation of the boiler.  
 Too high values of 0619 mean long delays in activating the boiler

**KM4 DHW storage electric heater**

An electric heater can be managed for heating the DHW storage.

**DHW storage electric heater control**

The electric heater is activated to reach a temperature value that the heat pump on its own is not able to reach.

Example:

Domestic hot water temperature produced with heat pump 0023 = 55°C

Domestic hot water temperature produced with electric heater 0209 = 65°C.

The electric heater works so as to increase the DHW storage temperature from 55°C to 65°C, figure 1

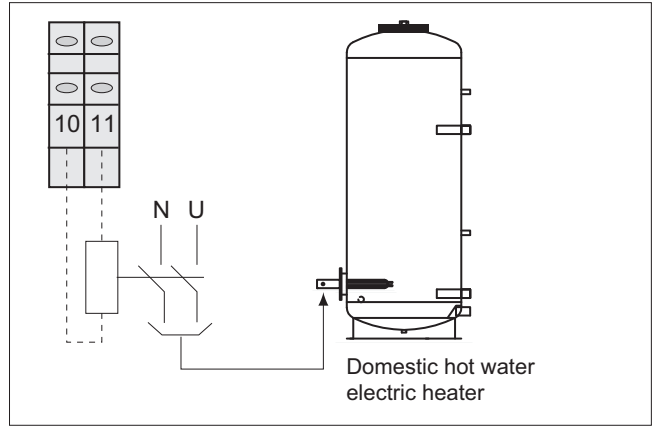

Description	Menu	Parameter no.	Value to be set	UOM
Electric heater operating mode 0 = Heat pump only 1 = Electric heater only 2 = Heat pump + Electric heater	Mn02	0202	2	
Domestic hot water temperature set point with heat pump	Mn00	0023	Example 55	°C
Domestic hot water temperature set point with heater	Mn02	0209	Example 65	°C

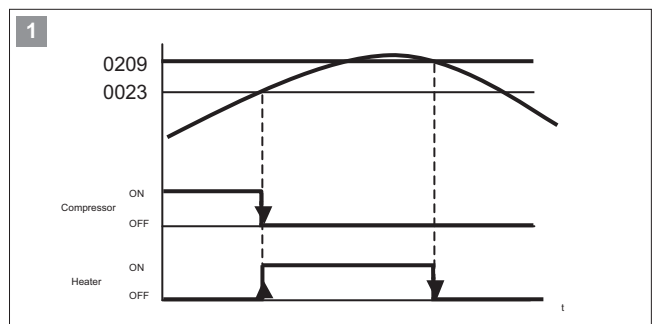

**Legionella prevention function with electric heater**

The Legionella prevention function ensures the elimination of the Legionella bacteria that reside in domestic water storage tanks. The temperature and duration of the Legionella prevention cycles are typically:

- 2 minutes > 70°C
- 4 minutes > 65°C
- 60 minutes > 60°C

To enable the Legionella prevention function, set 0222=1

Description	Menu	Parameter no.	Value to be set	UOM
Domestic hot water heating 0 = heat pump only 1 = electric heater only 2 = heat pump + electric heater	Mn02	0202	2	
Legionella prevention function with: 0 = heat pump only 1 = electric heater only 2 = heat pump + electric heater	Mn02	0223	1	
Domestic hot water temperature set point for Legionella prevention	Mn02	0211	Example 65°C	°C
Legionella prevention cycle day MONDAY (0=no; 1=yes)	Mn02	0213	0	
Legionella prevention cycle day TUESDAY (0=no; 1=yes)	Mn02	0214	0	
Legionella prevention cycle day WEDNESDAY (0=no; 1=yes)	Mn02	0215	Example 1	
Legionella prevention cycle day THURSDAY (0=no; 1=yes)	Mn02	0216	0	
Legionella prevention cycle day FRIDAY (0=no; 1=yes)	Mn02	0218	0	
Legionella prevention cycle day SATURDAY (0=no; 1=yes)	Mn02	0219	0	
Legionella prevention cycle day SUNDAY (0=no; 1=yes)	Mn02	0220	0	
Legionella prevention cycle time	Mn02	0221	02	h
Enable Legionella prevention function 0 = Not enabled 1 = Enabled	Mn02	0222	1	
Maximum Legionella prevention function duration	Mn02	0225	20	min.

**HL1 Configurable contact**

This contact can be configured for the following functions:

- Alarm signal
- Secondary circuit pump
- Dehumidifier

**Alarm signal**

A visual or audible signal device can be activated if the unit shuts down due to a malfunction.

Configure the contact, selecting the desired function by setting parameter 015A:

Description	Menu	Parameter no.	Value to be set	UOM
Enable the contact as: 0= Alarm signal 1= Dehumidifier 3= Secondary circuit pump	Mn01	015A	0	-

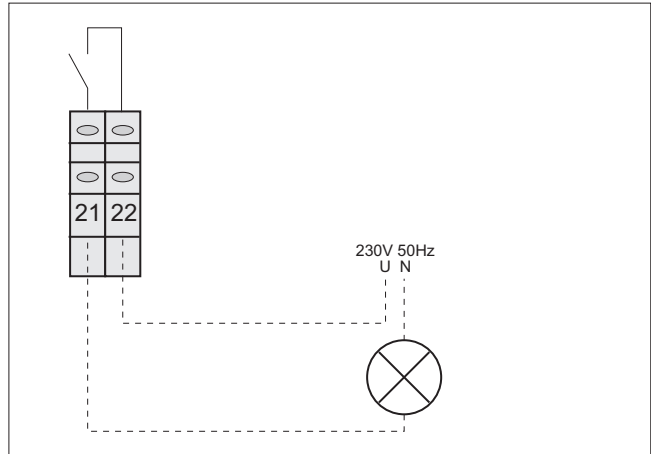

**Secondary circuit pump**

If the system features a low-loss header, contact HL1 can be used to activate the circulating pump on the secondary circuit.

Configure the contact, selecting the desired function by setting parameter 015A:

Description	Menu	Parameter no.	Value to be set	UOM
Enable the contact as: 0= Alarm signal 1= Dehumidifier 3= Secondary circuit pump	Mn01	015A	3	-

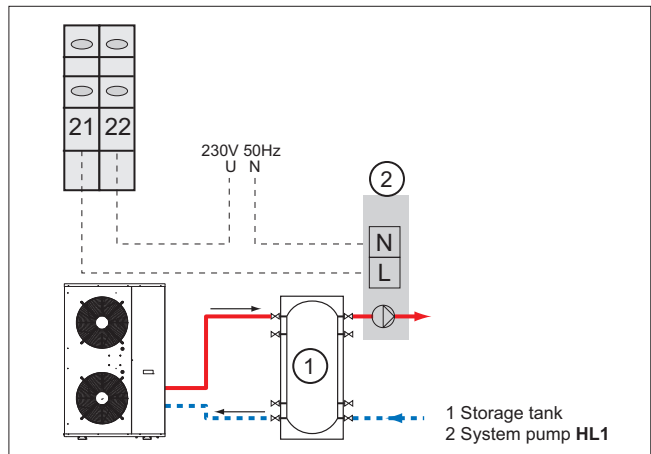

**Dehumidifier**

A dehumidifier can be activated in radiant panel systems to reduce humidity in cooling mode.

The contact closes and the dehumidifier is activated when the humidity measured by the probe on the A5 room controller exceeds the value set for parameter 0172.

Configure the contact, selecting the desired function by setting parameter 015A:

Description	Menu	Parameter no.	Value to be set	UOM
Enable the contact as: 0= Alarm signal 1= Dehumidifier 3= Secondary circuit pump	Mn01	015A	1	-

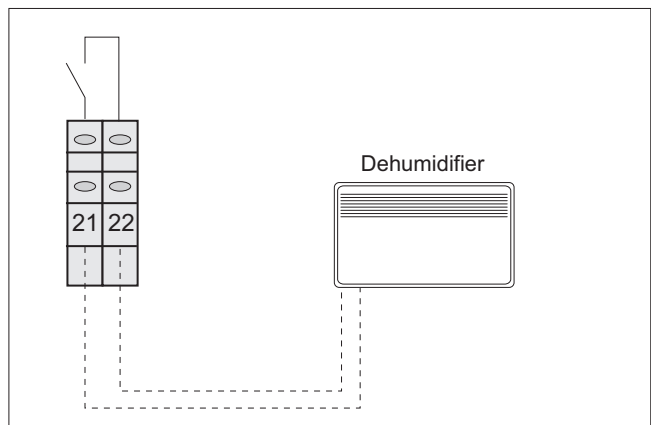

**HL2 Compressor ON signal**

A remote visual signal device can be activated to indicate compressor operation.

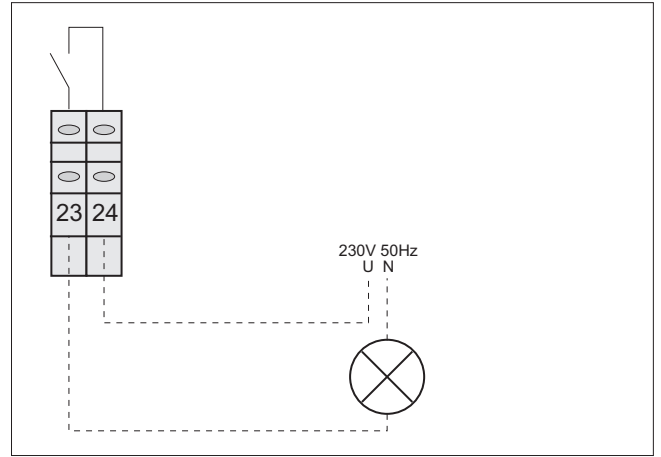

**SA1 Remote ON/OFF**

The unit can be switched on/off from a remote control unit, for example a timer or room thermostat.

The remote off function stops the compressor, fan and pumps, while frost protection remains active.

- The unit can be switched on/off from contact SA1 only when the unit has been switched on using the mode button on the A5 room controller

Contact closed = Heat pump ON  
Contact open = Heat pump OFF

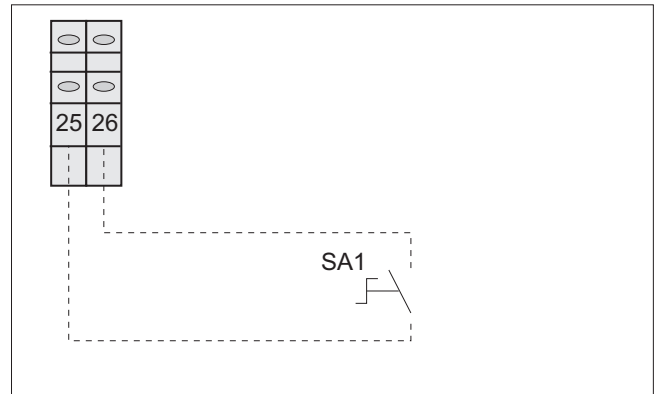

**SA2 Remote cooling/heating**

Cooling/heating operating mode can be managed from a remote control unit.

If remote cooling/heating changeover is enabled, the operating mode cannot be changed on the keypad.

Set the following parameters:

Description	Menu	Parameter no.	Value to be set	UOM
Enable remote contact 0= remote contact enabled 1= remote contact disabled (only from keypad)	Mn01	0100	0	-

Contact closed = Cooling  
Contact open = Heating

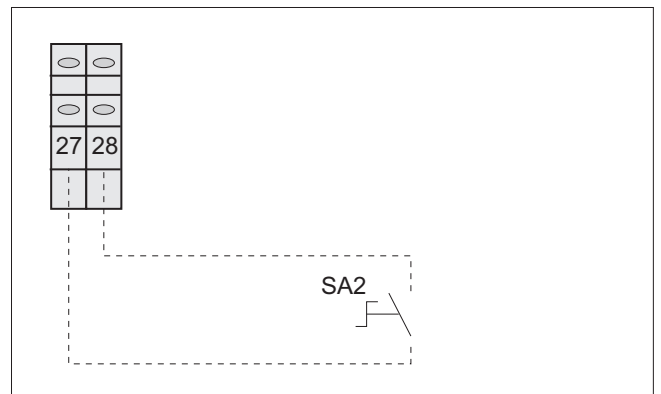

**SA3 Remote system/domestic water priority**

The priority of heat pump operation can be selected using a remote contact.

Use a switch to select the following functions:

Contact closed = Domestic hot water only  
Contact open = Domestic hot water + System

Set the following parameters:

Description	Menu	Parameter no.	Value to be set	UOM
Enable remote contact 0= remote contact enabled 1= remote contact disabled (selection from keypad only)	Mn01	0100	0	-

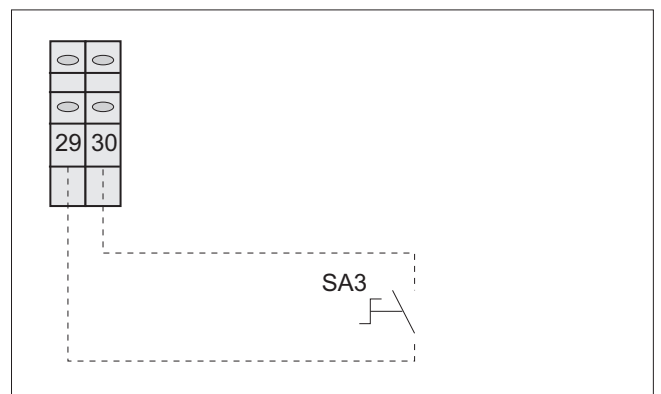

**SA5 Deactivation contact for excess power consumption**

The heat pump accepts an external deactivation signal from contact SA5 if a power consumption management system is used to disconnect devices based on set priority, thus avoiding activation of the contactor on the power meter. Configure the contact, selecting the desired function by setting parameter 015D:

Description	Menu	Parameter no.	Value to be set	UOM
Enable the contact as: 0=Reduced electricity rate 1=Stop operation due to excess power consumption	Mn01	015D	1	-

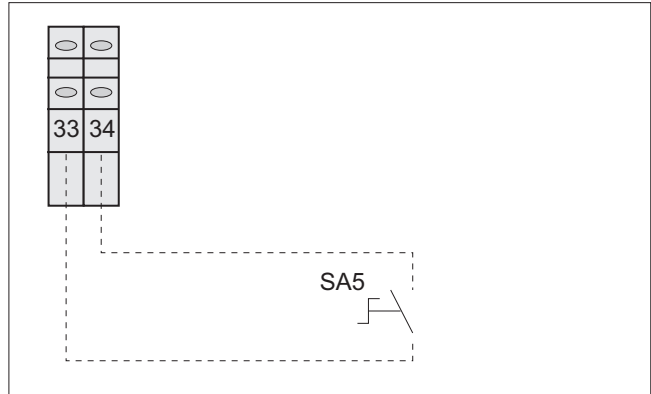

Contact closed: heat pump operation not allowed.  
Contact open: heat pump operation allowed.

**SA5 Reduced electricity rate contact**

Forced refilling of the reserve storage tanks can be activated based on different electricity rates during the day. During reduced rate periods, the heat pump can be forced on so as to heat the domestic hot water or system storage tank, where fitted. Configure the contact, selecting the desired function by setting parameter 015D:

Description	Menu	Parameter no.	Value to be set	UOM
Enable the contact as: 0=Reduced electricity rate 1=Stop operation due to excess power consumption	Mn01	015D	0	-
Enable the set point as: 0= Economy 1= Comfort	Mn00	0015	0	-
Set the value of the domestic hot water ECONOMY set point	Mn00	0022	Example 47	°C
Set the value of the domestic hot water COMFORT set point	Mn00	0023	Example 50	°C

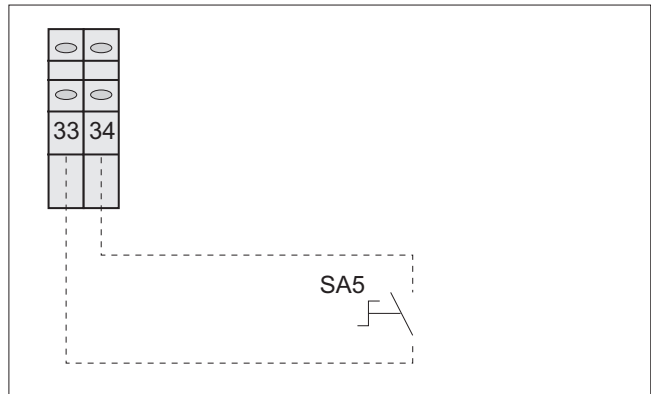

Contact closed: forced operation during the reduced rate period.  
Contact open: heat pump operation at full electricity rate.

During operation at reduced electricity rate, contact closed, the domestic hot water set point is 50°C, as shown in the example, with the contact open it's 47°C. This allows operation at a higher temperature, within the unit's operating limits, exploiting the lower electricity cost.



**F3 System flow switch**

System flow switch connection, compulsory component.

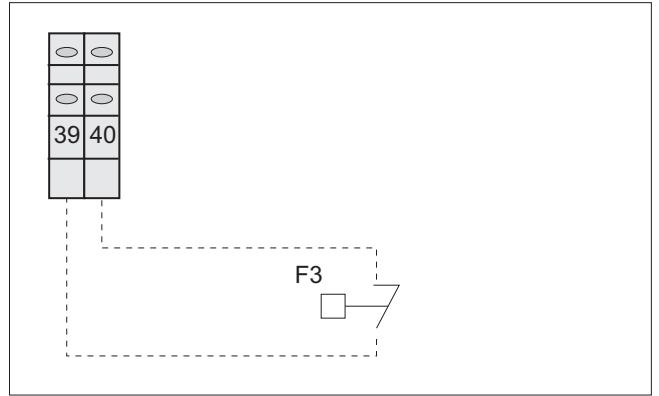

**BT8 Domestic hot water storage temperature probe**

The domestic hot water temperature inside the storage tank is measured using probe BT8

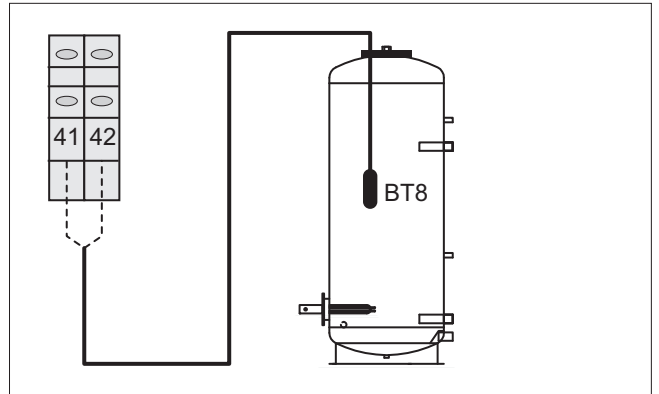

**ELECTRICAL PANEL LAYOUT**  
**AWR-MTD2-XE 0011÷0041 SINGLE-PHASE**

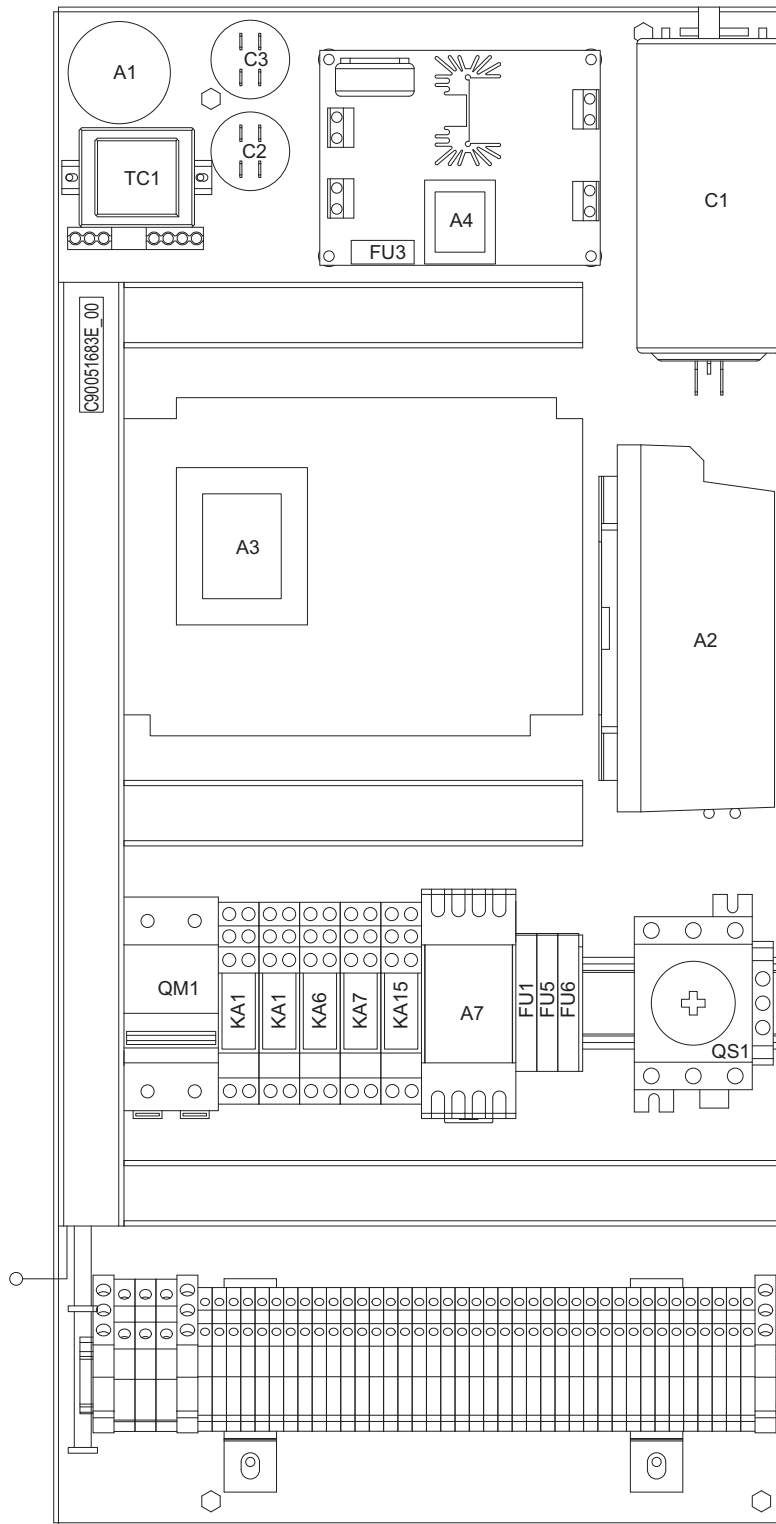

- |      |                                   |      |   |
|------|-----------------------------------|------|---|
| A1   | Radio interference suppresser     | FU6  | Controller protection fuse              |
| A2   | Peak limiter                      | TC1  | Autotransformer                         |
| A3   | Electronic controller             | KA1  | Compressor control relay                |
| A4   | Fan control module                | KA6  | Outlet heater or boiler relay           |
| A7   | Electric heater actuator          | KA7  | Alarm/secondary pump/dehumidifier relay |
| C1   | Compressor start capacitor        | KA15 | High pressure switch relay              |
| C2-3 | Fan start capacitor               | QM1  | Compressor circuit breaker              |
| FU1  | System water pump protection fuse | QS1  | Door interlock disconnect switch        |
| FU3  | Fan protection fuse               |      |   |
| FU5  | Auxiliary circuit protection fuse |      |   |

**ELECTRICAL PANEL LAYOUT  
AWR-MTD2-XE 0031+0051 THREE-PHASE**

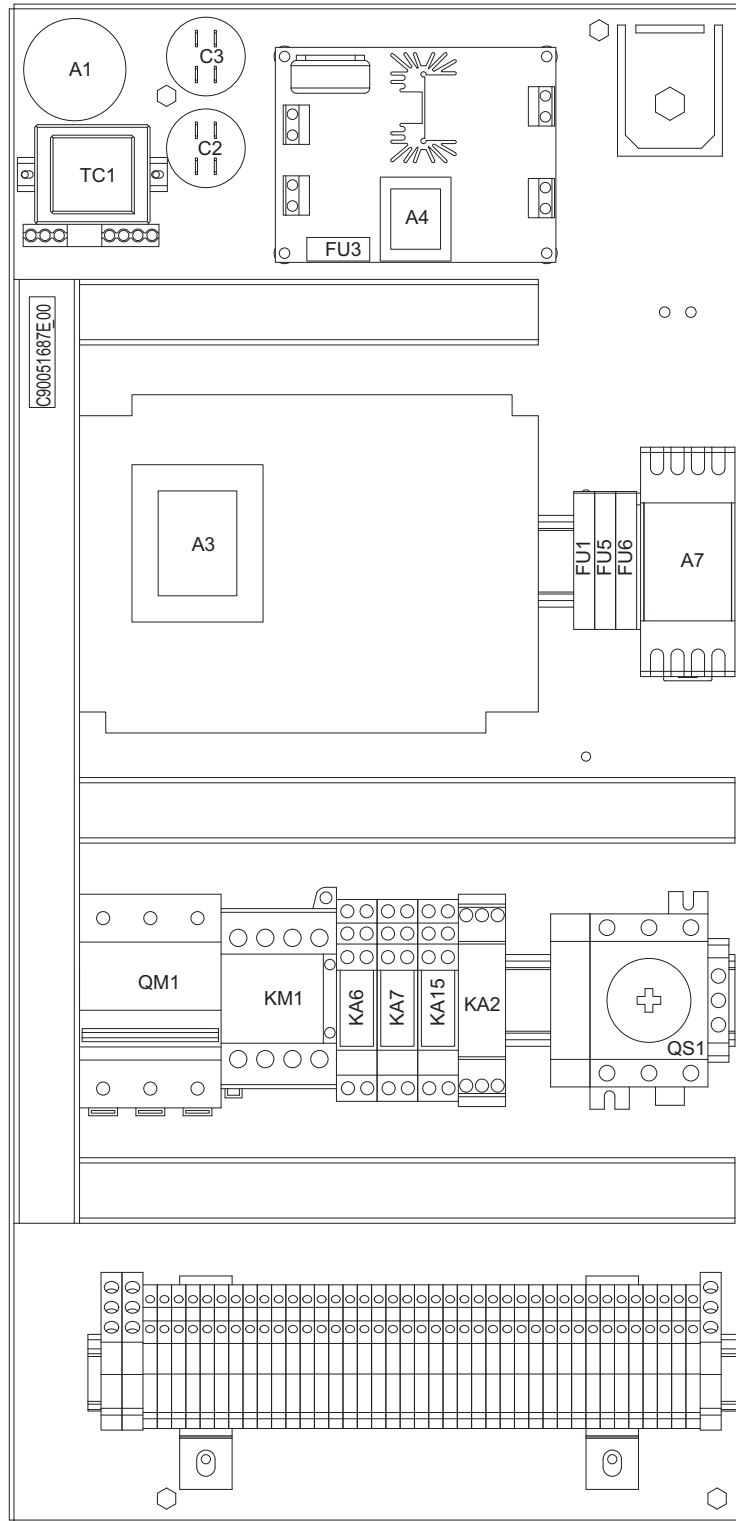

- |      |                                   |      |   |
|------|-----------------------------------|------|---|
| A1   | Radio interference suppresser     | KA2  | Phase sequence control relay            |
| A3   | Electronic controller             | KA6  | Outlet heater or boiler relay           |
| A4   | Fan control module                | KA7  | Alarm/secondary pump/dehumidifier relay |
| A7   | Electric heater actuator          | KA15 | High pressure switch relay              |
| C2-3 | Fan start capacitor               | KM1  | Compressor contact                      |
| FU1  | System water pump protection fuse | QM1  | Compressor circuit breaker              |
| FU3  | Fan protection fuse               | QS1  | Door interlock disconnect switch        |
| FU5  | Auxiliary circuit protection fuse |      |   |
| FU6  | Controller protection fuse        |      |   |
| TC1  | Autotransformer                   |      |   |

**ELECTRICAL PANEL LAYOUT  
AWR-MTD2-XE 0061 AND 0091 THREE-PHASE**

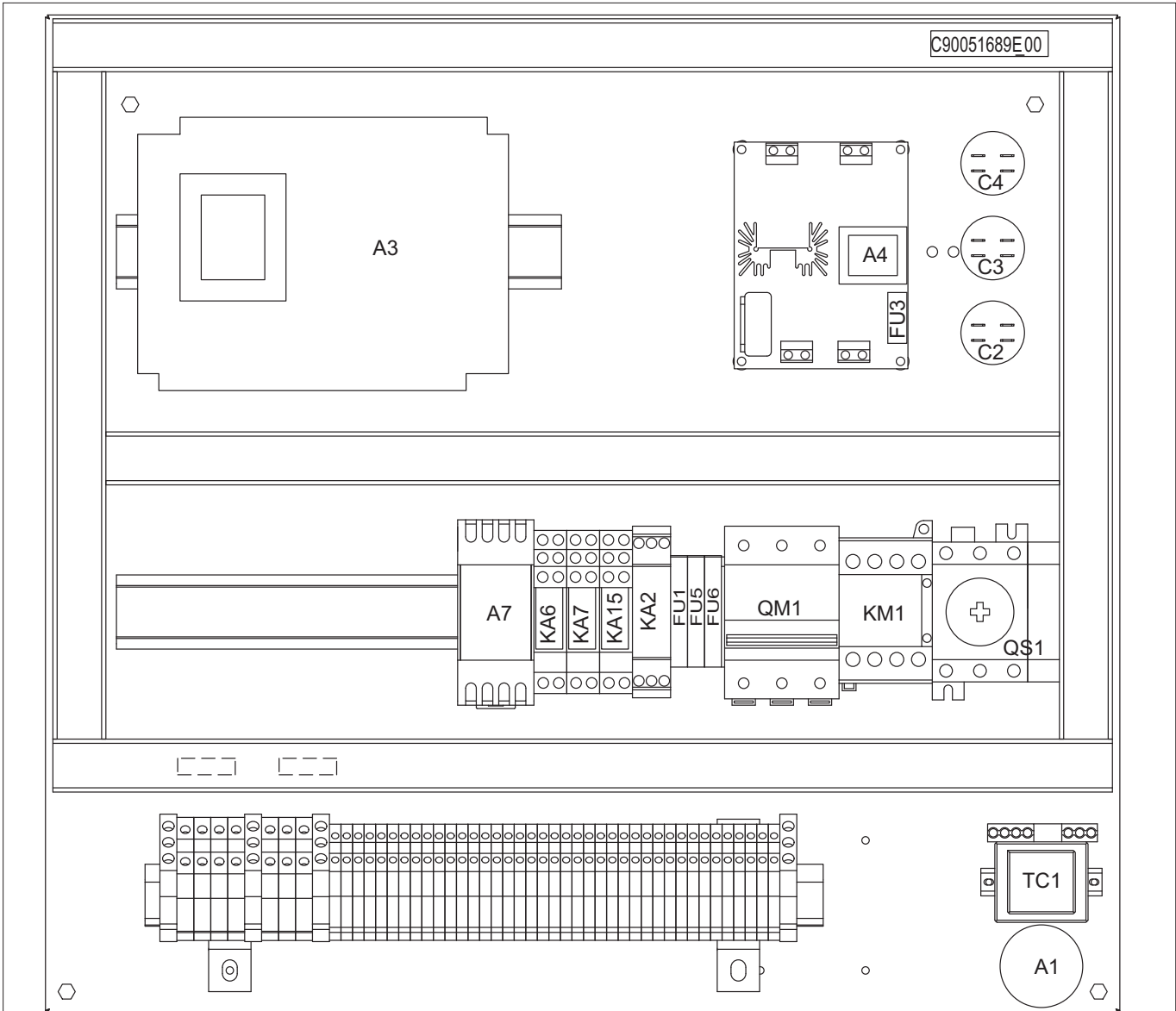

- |        |                                   |      |   |     |                                  |
|--------|-----------------------------------|------|---|-----|----------------------------------|
| A1     | Radio interference suppresser     | FU5  | Auxiliary circuit protection fuse       | KM1 | Compressor contact               |
| A3     | Electronic controller             | FU6  | Controller protection fuse              | QM1 | Compressor circuit breaker       |
| A4     | Fan control module                | TC1  | Autotransformer                         | QS1 | Door interlock disconnect switch |
| A7     | Electric heater actuator          | KA2  | Phase sequence control relay            |     |                                  |
| C2-3-4 | Fan start capacitor               | KA6  | Outlet heater or boiler relay           |     |                                  |
| FU1    | System water pump protection fuse | KA7  | Alarm/secondary pump/dehumidifier relay |     |                                  |
| FU3    | Fan protection fuse               | KA15 | High pressure switch relay              |     |                                  |

SINGLE-PHASE WIRING DIAGRAM AWR-MTD2-XE 0011+0041

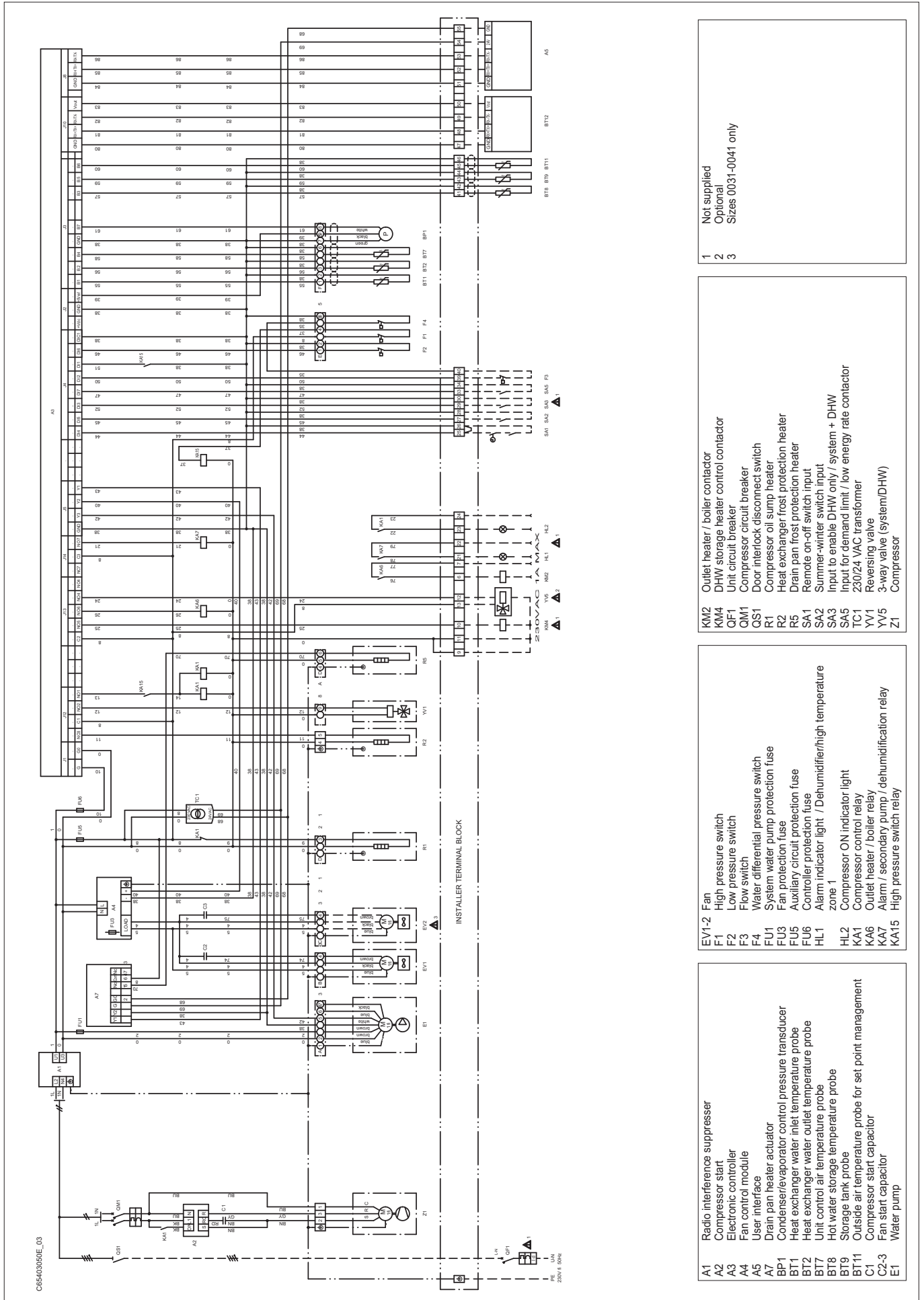

C65403060E\_03

- 1 Not supplied
- 2 Optional
- 3 Sizes 0031-0041 only

- KIM2 Outlet heater / boiler contactor
- KIM4 DHW storage heater control contactor
- OF1 Unit circuit breaker
- OM1 Compressor circuit breaker
- OS1 Door interlock disconnect switch
- R1 Compressor oil sump heater
- R2 Heat exchanger frost protection heater
- R5 Drain pan frost protection heater
- SA1 Remote on-off switch input
- SA2 Summer-winter switch input
- SA3 Input to enable DHW only / system + DHW
- SA5 Input for demand limit / low energy rate contactor
- TC1 230/24 VAC transformer
- YV1 Reversing valve
- YV5 3-way valve (system/DHW)
- Z1 Compressor

- EV1-2 Fan
- F1 High pressure switch
- F2 Low pressure switch
- F3 Flow switch
- F4 Water differential pressure switch
- FU1 System water pump protection fuse
- FU3 Fan protection fuse
- FU5 Auxiliary circuit protection fuse
- FU6 Controller protection fuse
- HL1 Alarm indicator light / Dehumidifier/high temperature zone 1
- HL2 Compressor ON indicator light
- KA1 Compressor control relay
- KA7 Outlet heater / boiler relay
- KA8 Alarm / secondary pump / dehumidification relay
- KA15 High pressure switch relay

- A1 Radio interference suppresser
- A2 Compressor start
- A3 Electronic control
- A4 Fan control module
- A5 User interface
- A7 Drain pan heater actuator
- BP1 Condenser/evaporator control pressure transducer
- BT1 Heat exchanger water inlet temperature probe
- BT2 Heat exchanger water outlet temperature probe
- BT7 Unit control air temperature probe
- BT8 Hot water storage temperature probe
- BT9 Storage tank probe
- BT11 Outside air temperature probe for set point management
- C1 Compressor start capacitor
- C2-3 Fan start capacitor
- E1 Water pump

THREE-PHASE WIRING DIAGRAM AWR-MTD2-XE 0031+0051

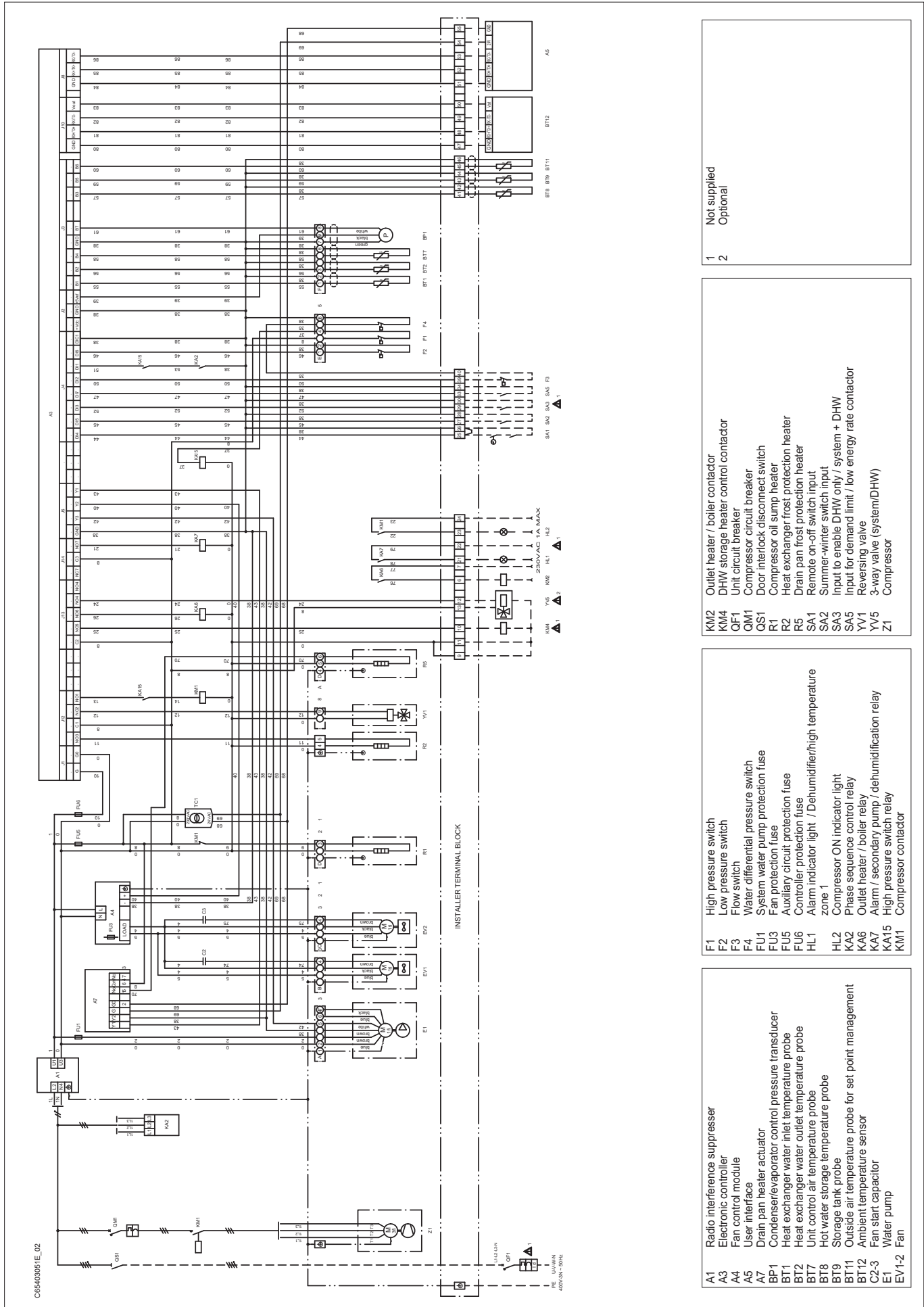

1 Not supplied  
2 Optional

KM2 Outlet heater / boiler control  
KM4 DHW storage heater control contactor  
QF1 Unit circuit breaker  
QM1 Compressor circuit breaker  
QS1 Door interlock disconnect switch  
R1 Compressor oil sump heater  
R2 Heat exchanger frost protection heater  
R5 Drain pan frost protection heater  
SA1 Remote on-off switch input  
SA2 Summer-winter switch input  
SA3 Input to enable DHW only / system + DHW  
SA5 Input for demand limit / low energy rate contactor  
YV1 Reversing valve  
YV5 3-way valve (system/DHW)  
Z1 Compressor

F1 High pressure switch  
F2 Low pressure switch  
F3 Flow switch  
F4 Water differential pressure switch  
FU1 System water pump protection fuse  
FU3 Fan protection fuse  
FU5 Auxiliary circuit protection fuse  
FU6 Controller protection fuse  
HL1 Alarm indicator light / Dehumidifier/high temperature zone 1  
HL2 Compressor ON indicator light  
KA2 Phase sequence control relay  
KA7 Outlet heater / boiler relay  
KA8 Alarm / secondary pump / dehumidification relay  
KA15 High pressure switch relay  
KM1 Compressor contactor

A1 Radio interference suppressor  
A3 Electronic controller  
A4 Fan control module  
A5 User interface  
A7 Drain pan heater actuator  
BP1 Condenser/evaporator control pressure transducer  
BT1 Heat exchanger water inlet temperature probe  
BT2 Heat exchanger water outlet temperature probe  
BT7 Unit control air temperature probe  
BT8 Hot water storage temperature probe  
BT9 Storage tank probe  
BT11 Outside air temperature probe for set point management  
BT12 Ambient air temperature sensor  
C2-3 Fan start capacitor  
E1 Water pump  
EV1-2 Fan

THREE-PHASE WIRING DIAGRAM AWR-MTD2-XE 0061+0091

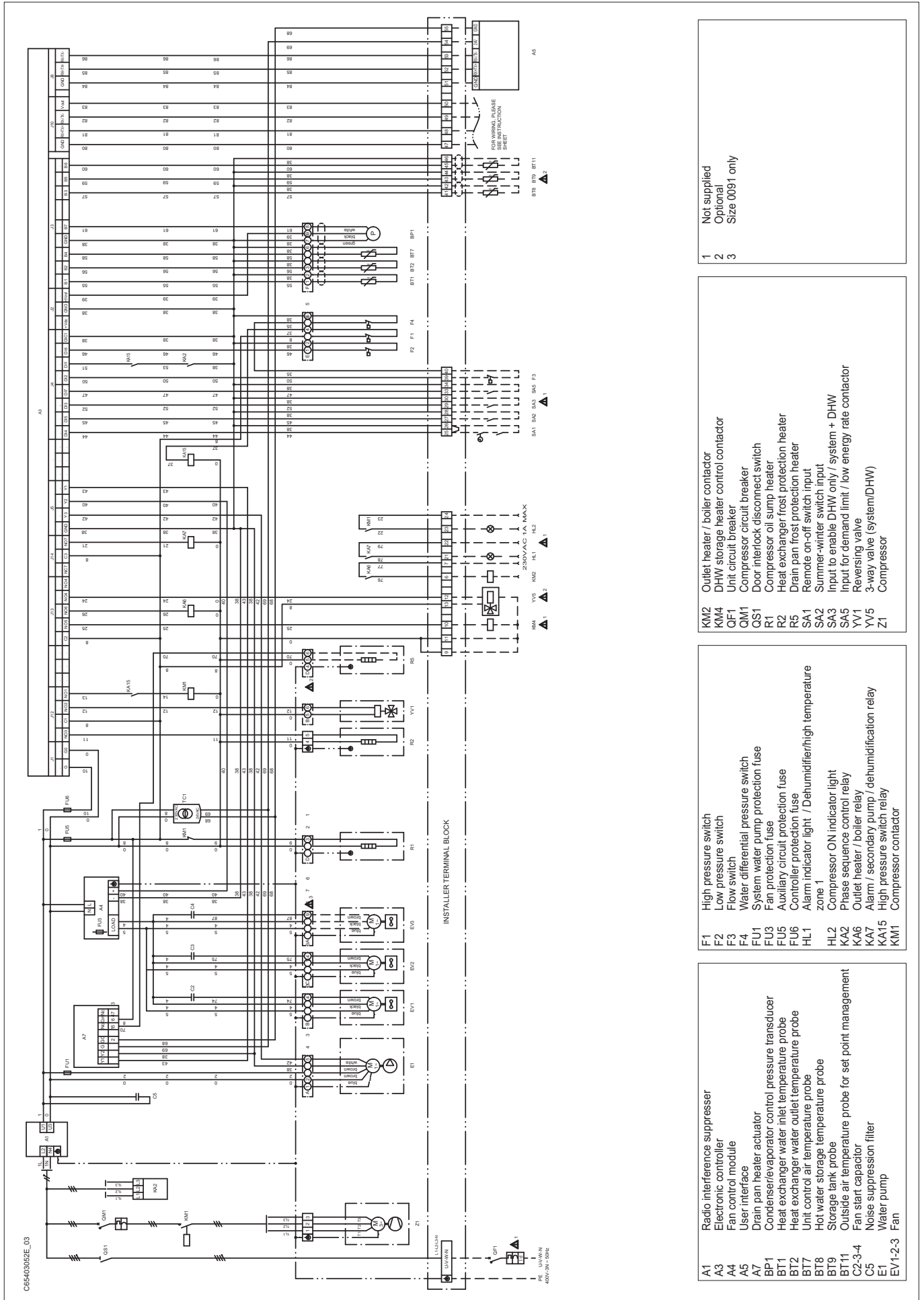

- 1 Not supplied
- 2 Optional
- 3 Size 0091 only

- KM2 Outlet heater / boiler contactor
- KM4 DHW storage heater control contactor
- QF1 Unit circuit breaker
- OM1 Compressor circuit breaker
- QS1 Door interlock disconnect switch
- R1 Compressor oil sump heater
- R2 Heat exchanger frost protection heater
- R5 Drain pan frost protection heater
- SA1 Remote on-off switch input
- SA2 Summer-winter switch input
- SA3 Input to enable DHW only / system + DHW
- SA5 Input for demand limit / low energy rate contactor
- YV1 Reversing valve
- YV5 3-way valve (system/DHW)
- Z1 Compressor

- F1 High pressure switch
- F2 Low pressure switch
- F3 Flow switch
- F4 Water differential pressure switch
- FU1 System water pump protection fuse
- FU3 Fan protection fuse
- FU5 Auxiliary circuit protection fuse
- FU6 Controller protection fuse
- HL1 Alarm indicator light / Dehumidifier/high temperature zone 1
- HL2 Compressor ON indicator light
- KA2 Phase sequence control relay
- KA6 Outlet heater / boiler relay
- KA7 Alarm / secondary pump / dehumidification relay
- KA15 High pressure switch relay
- KM1 Compressor contactor

- A1 Radio interference suppresser
- A3 Electronic controller
- A4 Fan control module
- A5 User interface
- A7 Drain pan heater actuator
- BP1 Condenser/evaporator control pressure transducer
- BT1 Heat exchanger water inlet temperature probe
- BT2 Heat exchanger water outlet temperature probe
- BT7 Unit control air temperature probe
- BT8 Hot water storage temperature probe
- BT9 Storage tank probe
- BT11 Outside air temperature probe for set point management
- C2-3-4 Fan start capacitor
- C5 Noise suppression filter
- E1 Water pump
- EV1-2-3 Fan

AWR MT2 XE		0011	0025	0031	0041	0031	0041	0051	0061	0091	
Heating capacity (1)	kW	6,3	7,4	11,2	14	10,9	14	15,9	17,9	25,1	
Power input (2)	kW	1,5	1,8	2,6	3,3	2,6	3,3	3,8	4,2	6	
COP Eurovent		4,23	4,23	4,26	4,19	4,18	4,19	4,14	4,28	4,19	
COP EN14511		4,13	4,15	4,22	4,16	4,15	4,15	4,11	4,25	4,19	
Heating capacity (3)	kW	6,1	7,3	10,8	13,6	10,6	13,8	15,4	17,5	24,6	
Power input (2)	kW	1,9	2,3	3,3	4,1	3,2	4,3	4,6	5,2	7,4	
COP Eurovent		3,29	3,24	3,32	3,29	3,28	3,25	3,35	3,38	3,32	
Rated water flow (1)	m <sup>3</sup> /h	1,1	1,3	1,9	2,4	1,9	2,4	2,8	3,1	4,3	
Useful pressure head (1)	kPa	50	45	87	67	87	67	53	54	104	
Cooling capacity (4)	kW	7,2	8,3	12,3	15,7	11,7	15,8	17,7	20,2	29,2	
Power input (2)	kW	1,9	2,2	3,3	4,1	3,1	4,2	4,7	5,3	7,8	
EER Eurovent		3,79	3,77	3,73	3,83	3,77	3,76	3,77	3,81	3,74	
EER EN 14511		3,82	3,82	3,81	3,84	3,84	3,81	3,81	3,81	3,85	
Cooling capacity (5)	kW	5,2	6,3	9,2	11,7	8,6	11,9	13,2	15,2	22,1	
Power input(2)	kW	1,7	2,2	3,1	4	3	4	4,6	5	7,2	
EER Eurovent		3,06	2,86	2,97	2,93	2,87	2,98	2,87	3,04	3,07	
ESEER		3,62	3,63	3,52	3,46	3,42	3,65	3,24	3,55	3,57	
Rated water flow(4)	m <sup>3</sup> /h	1,2	1,4	2,1	2,7	2	2,7	3,1	3,5	5	
Useful pressure head(4)	kPa	43	40	80	55	80	55	43	42	88	
No. of fans	n°	1	1	2	2	2	2	2	2	3	
Air flow	m <sup>3</sup> /s	1,08	1,08	1,8	1,9	1,8	1,9	1,9	2,01	3	
Type of compressor		SCROLL									
Number of compressors	n°	1	1	1	1	1	1	1	1	1	
Number of circuits	n°	1	1	1	1	1	1	1	1	1	
Refrigerant R410a	Kg	2,55	2,9	3,5	4,35	3,5	4,35	4,5	6,1	8,5	
Oil Mobil EAL ARTIC 22cc	Kg	0,7	0,7	1,2	1,2	1,2	2,0	1,7	1,8	3,2	
Type of pump		Circulator									
Number pumps	n°	1	1	1	1	1	1	1	1	1	
Operating weight	kg	145	150	155	170	155	170	180	250	335	
Water fittings	inches	1	1	1	1-1/4	1	1-1/4	1-1/4	1-1/4	1-1/4	
Sound power (6)	dB(A)	69	69	71	71	71	71	71	72	74	
Sound pressure (7)	dB(A)	54	54	56	56	56	56	56	57	59	
Power supply	V/ph/Hz	230~50					400-3N~50				

Data measured in the following conditions:

- (1) Water in-out 30/35°C (plant side), outdoor air temperature 7°C b.s./ 6°C b.u.
- (2) Total input is obtained from compressor input and fan input.
- (3) Water in-out 23/18°C (plant side), outdoor air temperature 35°C b.s.
- (4) Water in-out 40/45°C (plant side), outdoor air temperature 7°C b.s./ 6°C b.u.
- (5) Water in-out 12/7°C (plant side), outdoor air temperature 35°C b.s.
- (6) Sound power level according to ISO 9614 and Eurovent 8/1
- (7) Average sound pressure level above one reflecting surface (Q=2) at 1 meter from the outside dimensions of the unit.



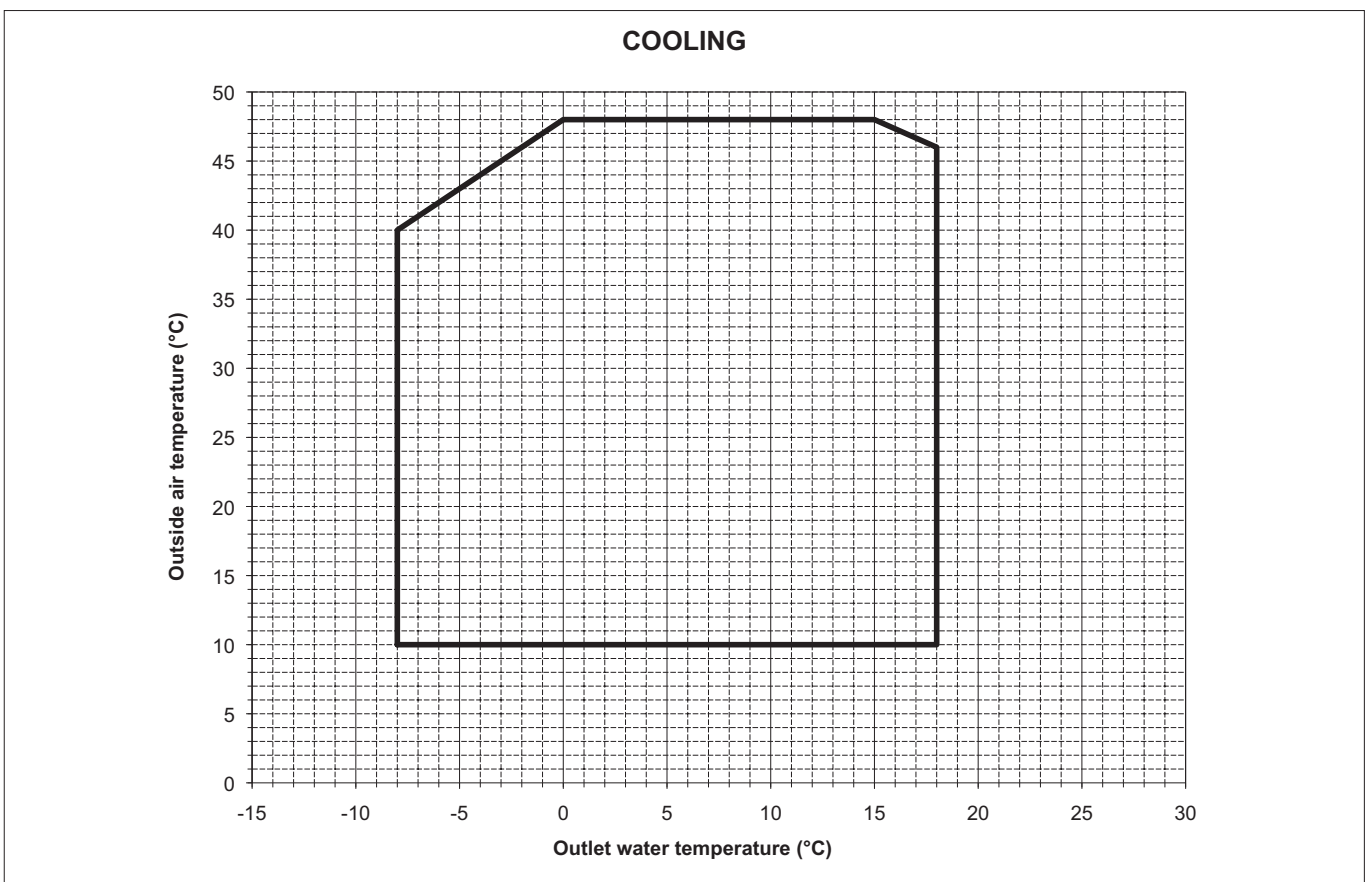
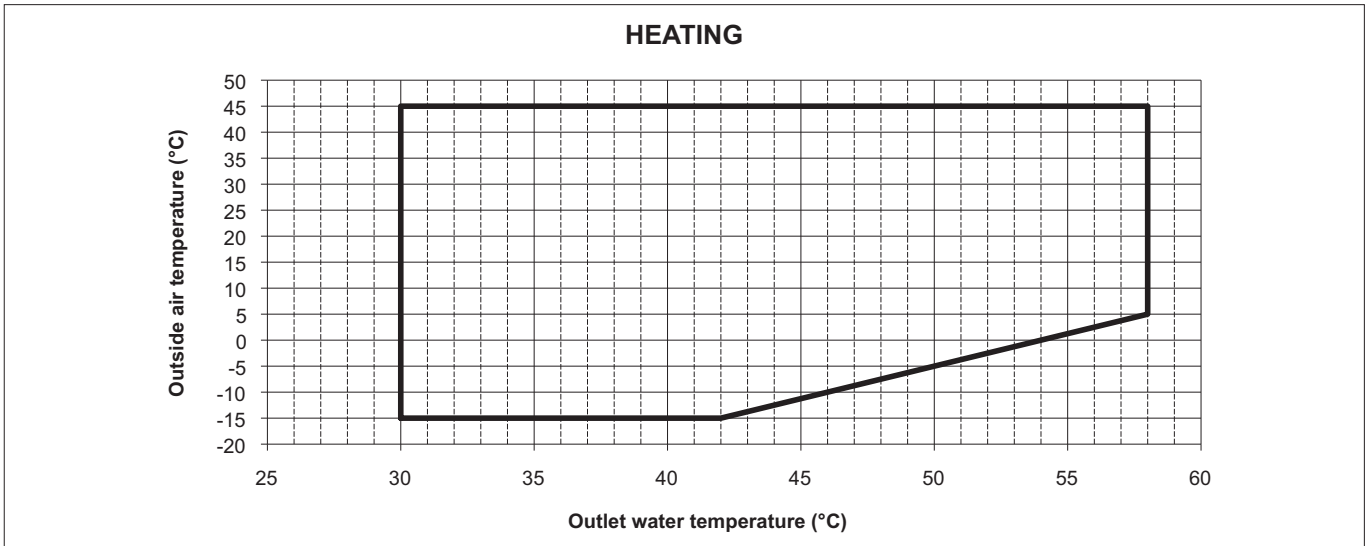

Water temperature head min/max= 3/8 °C  
 Water circuit pressure min/max = 1/3 bar  
 Maximum glycol percentage = 40%

CHARACTERISTICS AVAILABLE PRESSURE HEAD IN SYSTEM CIRCUIT

AWR MTD2 XE 11 ms

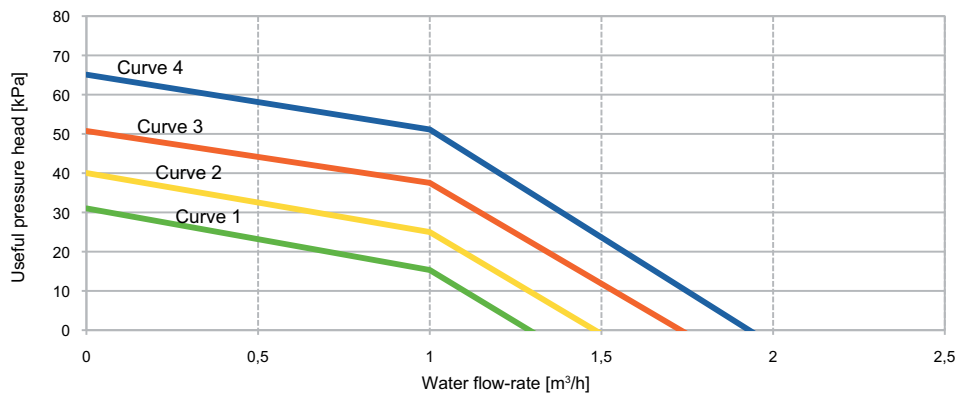

AWR MTD2 XE 25 ms

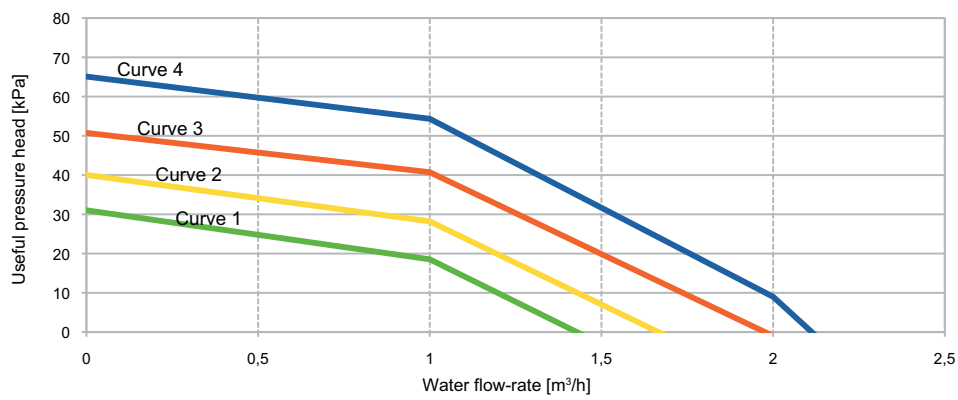

AWR MTD2 XE 31 ms - AWR MTD2 XE 31 t

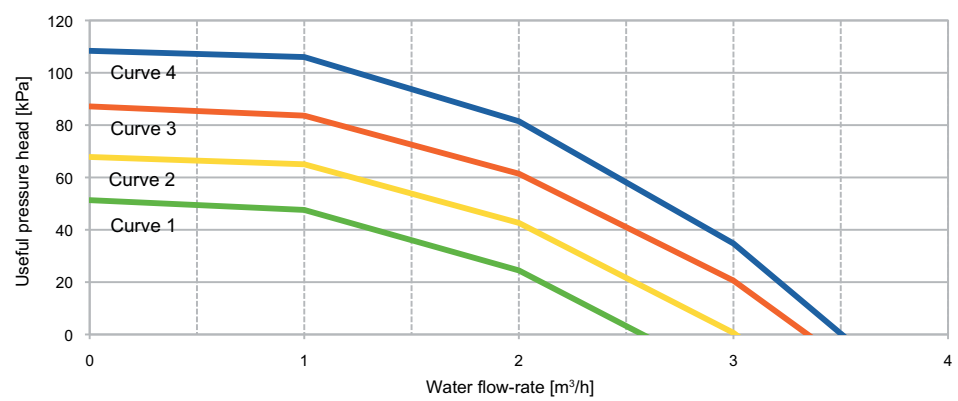

AWR MTD2 XE 41 ms - AWR MTD2 XE 41 t

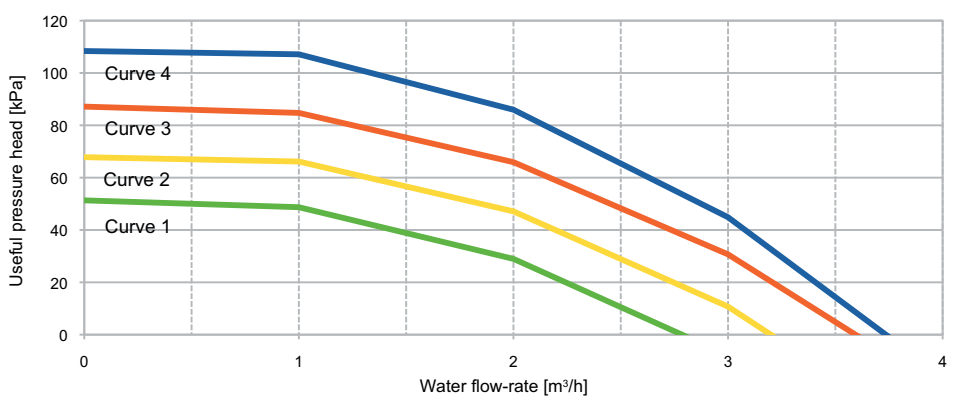

The pressure head refers to the values at the fittings.

CHARACTERISTICS AVAILABLE PRESSURE HEAD IN SYSTEM CIRCUIT

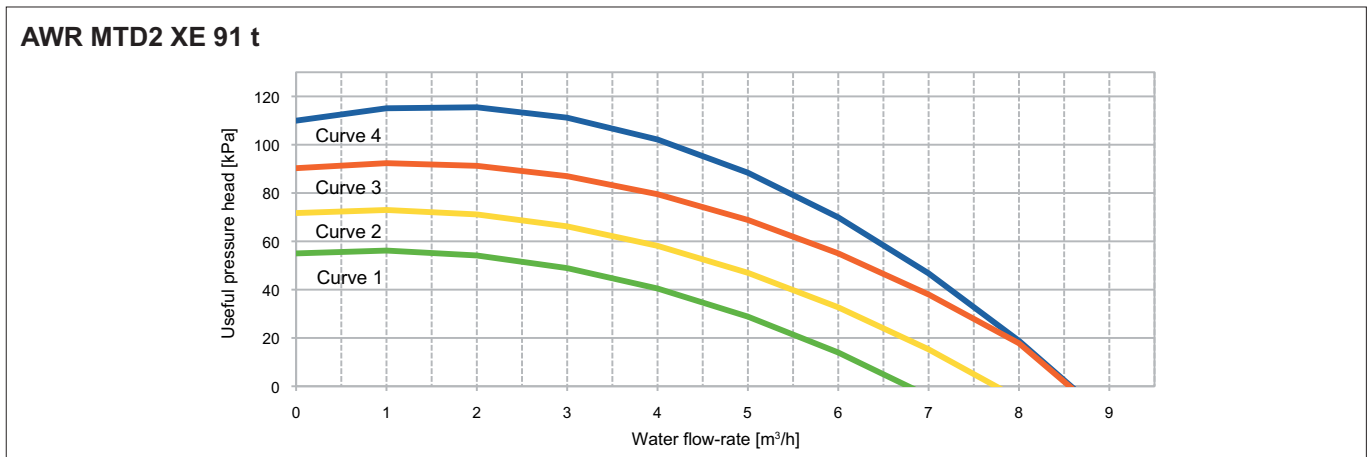
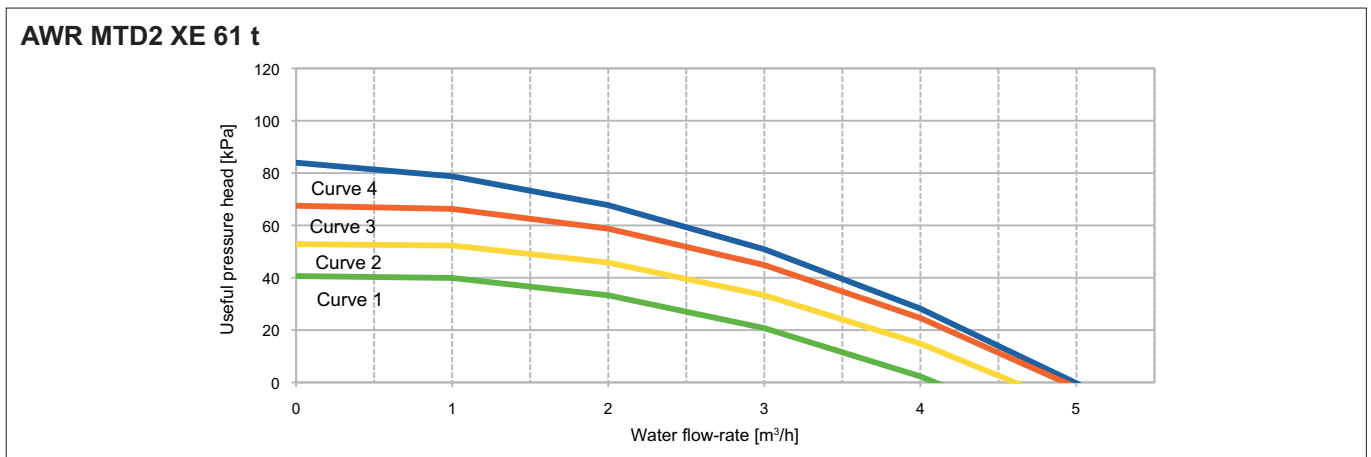
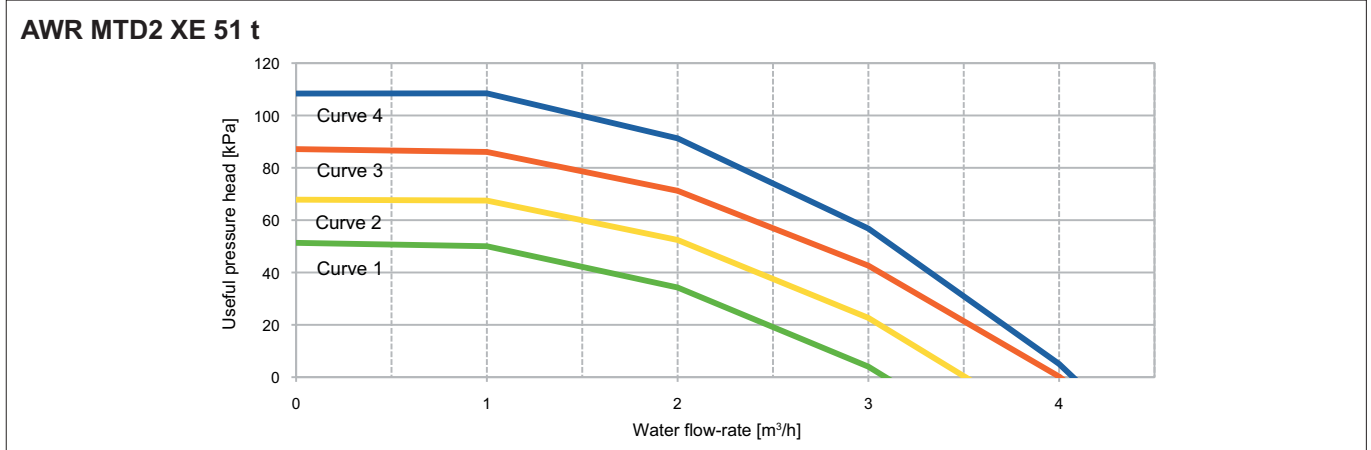

The pressure head refers to the values at the fittings.

### CHECKS BEFORE STARTING THE UNIT

- the vibration damping feet are fitted
- inlet filters are fitted on the system
- suitably-sized expansion vessel and safety valve installed on the DHW circuit
- an expansion vessel is installed if the expansion vessel on the unit is undersized
- make sure vibration damper joints are installed on water connections
- a low-loss header is installed if the water content is insufficient

- make sure the position of the outside air probe corresponds to the instructions shown in the manual
- make sure the position of the room control unit corresponds to the instructions shown in the manual
- make sure that the electrical power available is adequate for the unit installed
- make sure the non-return valve is installed on the DHW circuit

### PREPARING FOR FIRST START UP

The unit must be started up for the first time by the **Technical Service**. Before starting up the unit, make sure that:

- the unit has been properly installed as described in this manual
- All safety conditions have been respected;;
- The unit is adequately fixed to the surface it rests on;
- Clearances have been respected;
- Water connections have been carried out as indicated in the instruction manual;
- All water connections are tight.
- Make sure the water circuit has been washed and drained.
- The water circuit is filled and vented.
- Make sure there is no air in the system. If necessary vent the system using the vent valve.

If venting after operation in heat pump mode, be careful as the water may be hot;

- The water valves are open;
- Electrical connections have been carried out correctly;

- Voltage is within a tolerance of 10% of the rated voltage for the unit;
- Make sure that unbalance between phases is less than 3%, for three-phase units.
- The unit is correctly earthed;
- All electrical connections are tight.
- make sure that the outside air and water temperature are within the unit operating limits shown in this manual.

Before starting up, power up the unit for at least two hours by switching QF1 and QS1 to ON (see the wiring diagram) to allow the oil in the compressor sump to heat up.

### STARTING UP FOR THE FIRST TIME

Before starting the unit:

- Make sure the switch QF1 is in the OFF position, Fig. 1.
- Make sure the contact of the on/off device SA1 (see the wiring diagram) is open (if featured).
- Make sure the "A5" room controller is off.

- Position the main unit switch QS1 in the ON position, Fig. 2.

- Move switch QF1 (outside the unit) to "ON", Fig. 3.

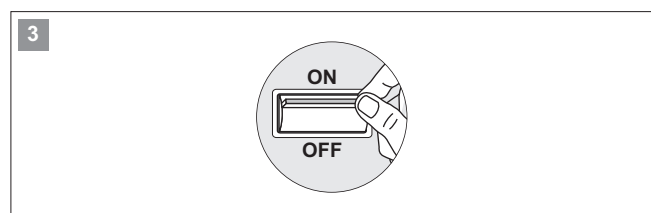
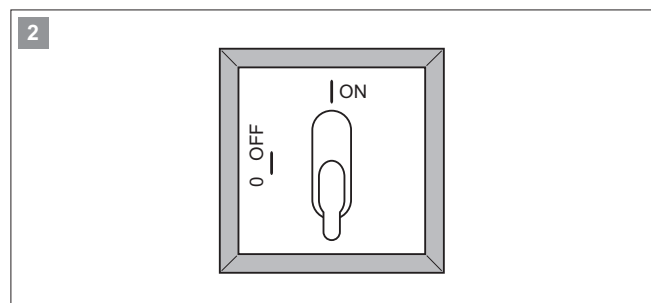
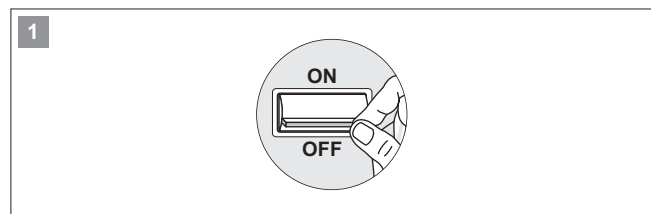

- Once having powered up the heat pump, the display on the room control unit shows this message (1):

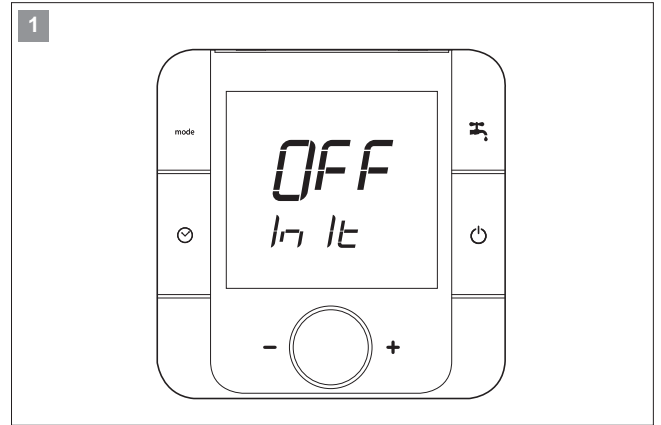

- Followed by (2):

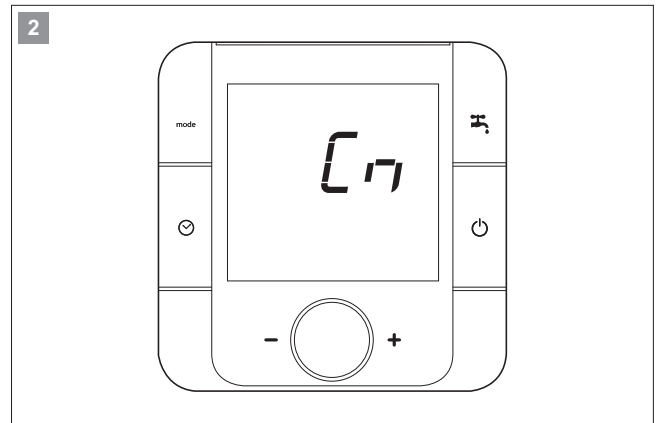

- Wait a few minutes, the unit is ready to operate when the display shows (3):

**⚠ Before starting up, power up the unit for at least two hours, with the compressor off, so as to allow the oil in the compressor sump to heat up.**

When commissioning the heat pump, the user must configure the type of system.

See the chapter "System configuration", check the application diagrams that the control unit is able to manage.

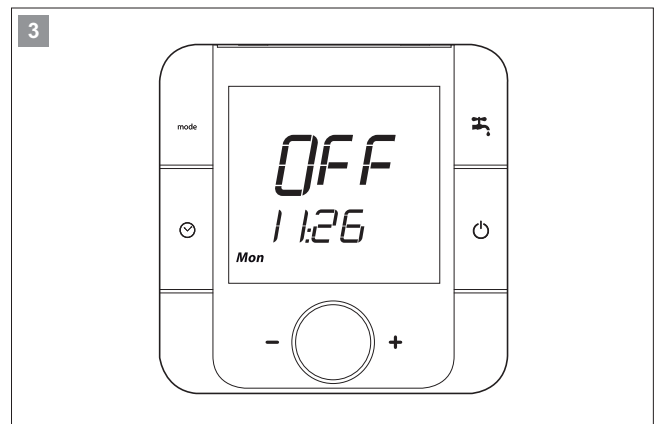

- Set the current date and time on the A5 room controller
- Configure the type of system and the number of A5 room controllers. See the chapter "System configuration".
- Switch on the unit by pressing button 3
- Select the required operating mode by pressing button 5
- Select the required room temperature by turning knob 4

For further information on the operation and functions of the room controller, see "Operation and functions of the room controller".

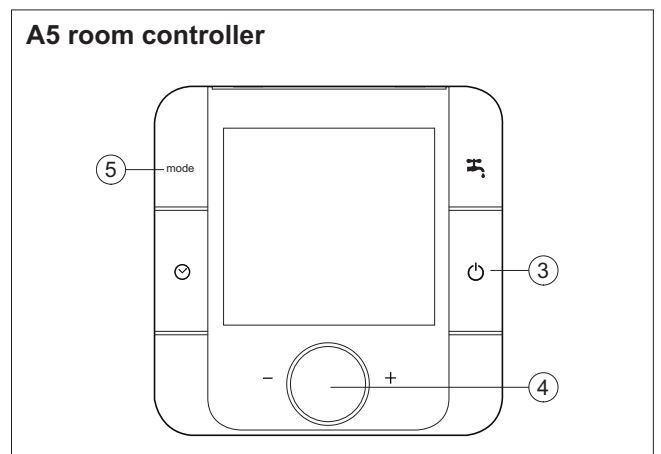

## BUTTONS

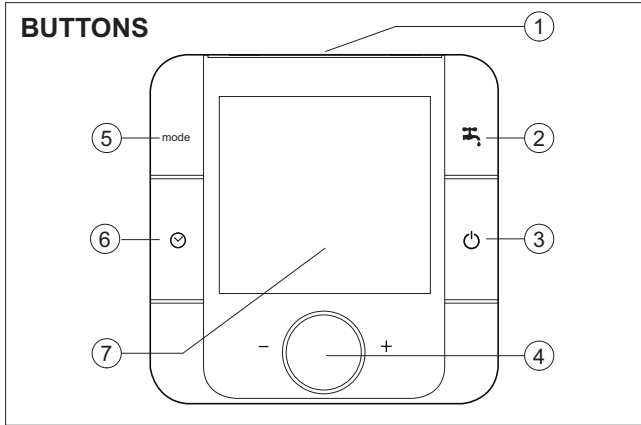

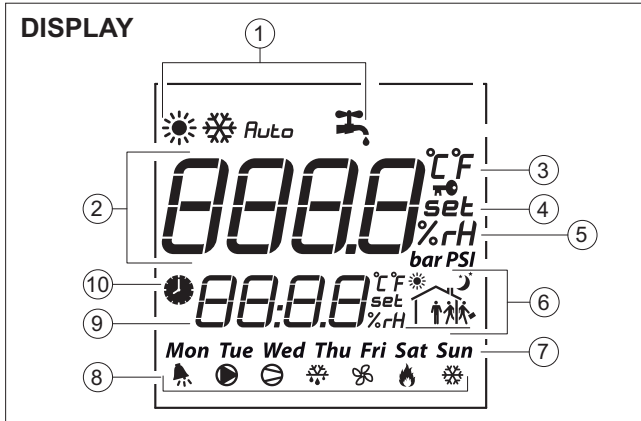

NO.	Description
1	Temperature and humidity probe
2	Domestic hot water (DHW) production button
3	ON/OFF button ESC button in parameter programming mode
4	Knob - Turning: scroll room temperature values, parameters and menus - Pressing: Confirm settings
5	Select operating mode button
6	Set time bands button
7	Backlit display

## DISPLAY



N°	Description	Symbol	Function
1	Operating mode		Heating
			Cooling
		<i>Auto</i>	automatic mode changeover based on outside air temperature
			Domestic hot water production enabled
2	Main field		Room temperature/humidity, room set point, parameter value display
3	Temperature unit of measure	$^{\circ}\text{C}/^{\circ}\text{F}$	
4	Set point	<i>set</i>	On indicates room set point programming
5	Relative humidity	<i>%rH</i>	
6	Time band		Indicates the type of active time band
7	Day of the week	<i>Mon...</i>	
8	Actuator operating		error message
			system pump active
			- flashing: compressor timer, delay
			- fixed: compressor active
			Defrost active
			Fan active
			Boiler or electric heater active
			Frost protection active
9	Secondary field		Time, menu, parameter number display
10	Active time band		On indicates active time band

**Meaning of the symbols**

Symbol	Meaning
	Press and release
	Hold for 3 seconds
	Turn the knob

**Display**



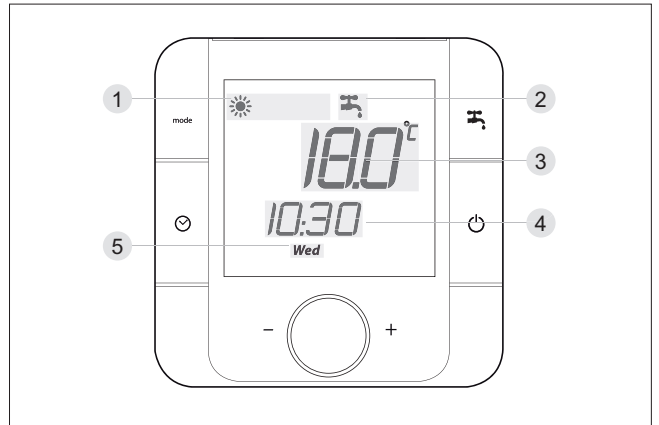

During normal operation of the unit, the display shows the following information:

1	operating mode selected
2	domestic hot water production enabled
3	room temperature
4	hour and minutes
5	day



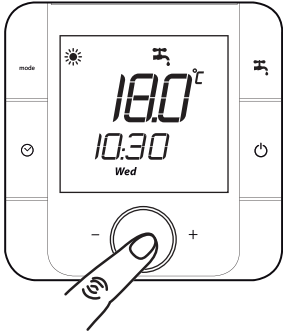
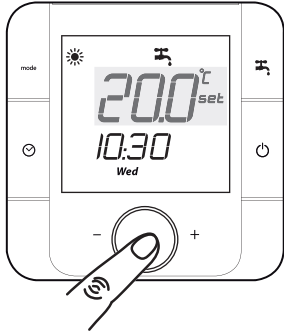

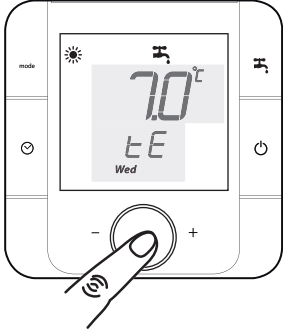
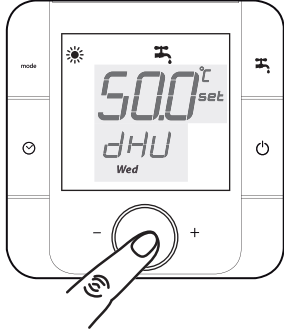

**Additional information displayed**

During operation of the unit, pressing the knob displays the information described below.

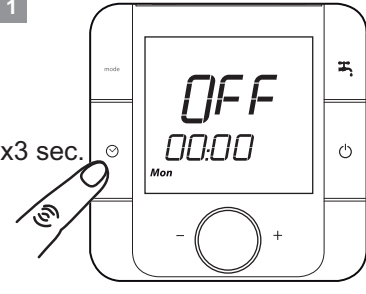
		
Press the knob	<b>Room temperature set point</b> Press the knob	<b>Humidity set point</b> Press the knob
		
<b>Outside air temperature</b> Press the knob	<b>Domestic hot water set point</b> Press the knob	<b>Room humidity</b> Press the knob

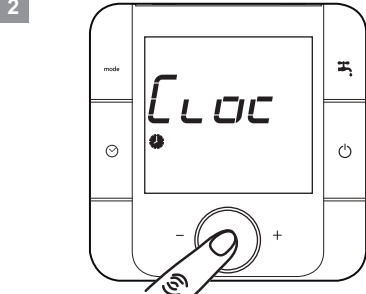
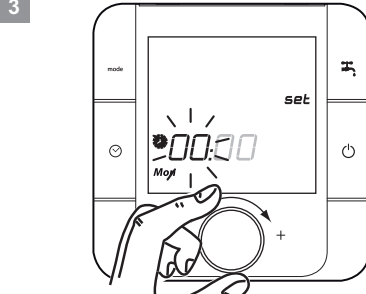
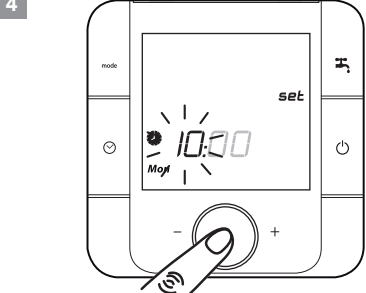
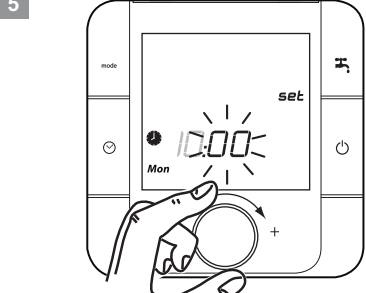
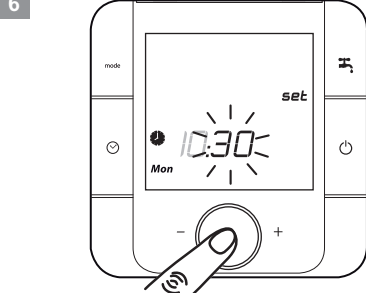
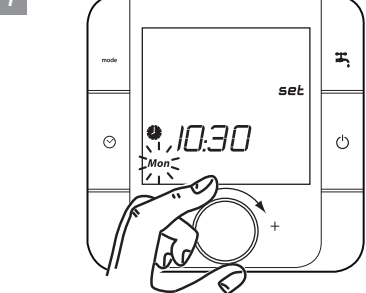
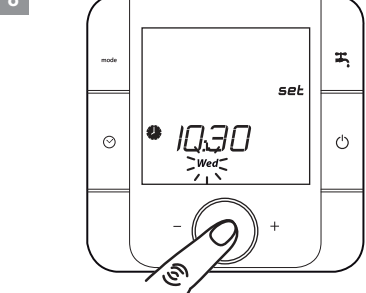
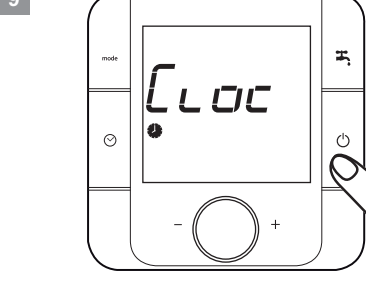
Setting the time and date

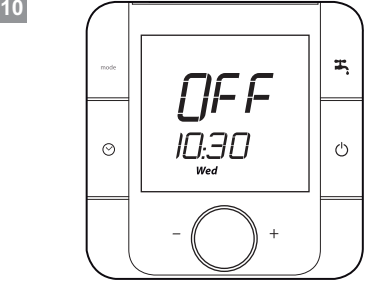
<p>1</p>  <p>x3 sec.</p> <p>Press the  button for 3 seconds</p>	<p>2</p>  <p>Press the knob</p>	<p>3</p>  <p>• The hours flash • Turn the knob to select the hour value</p>
<p>4</p>  <p>• Press the knob to confirm</p>	<p>5</p>  <p>• The minutes flash • Turn the knob to select the minutes value</p>	<p>6</p>  <p>• Press the knob to confirm</p>
<p>7</p>  <p>• The day flashes • Turn the knob to select the day**</p>	<p>8</p>  <p>• Press the knob to confirm</p>	<p>9</p>  <p>• Press the  button to exit.</p>
<p>10</p>  <p>• Main display</p>		

\*\* **Mon** = Lunedì, **Tue** = Martedì, **Wed** = Mercoledì, **Thu** = Giovedì, **Fri** = Venerdì, **Sat** = Sabato, **Sun** = Domenica



### Switching ON

The  button enables operation of the pump or the zone valve controlled by the room controller, the heat pump is activated by selecting the operating mode using the mode button, as shown below.

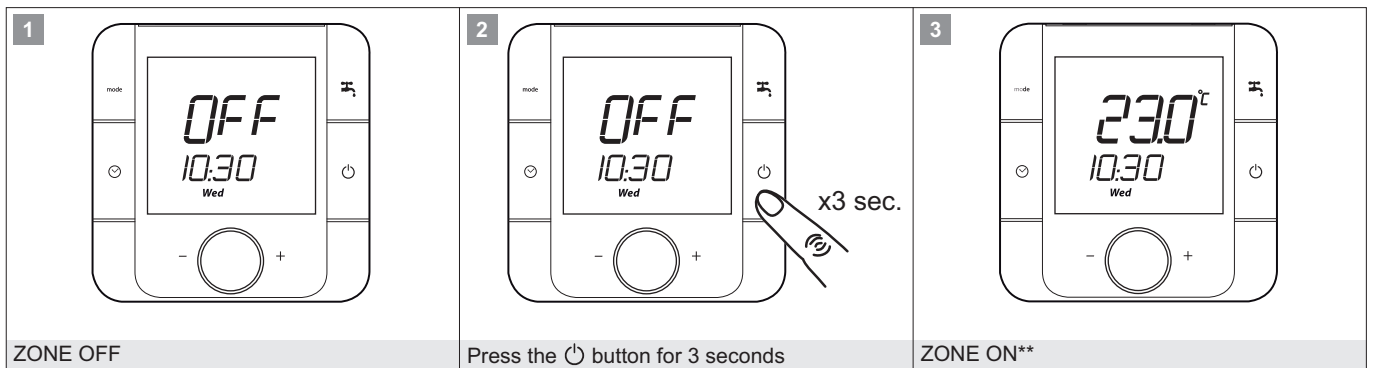

\*\* The heat pump is not yet operating, the mode has to be selected: heating, cooling, auto or domestic hot water production.

### Selecting the operating mode

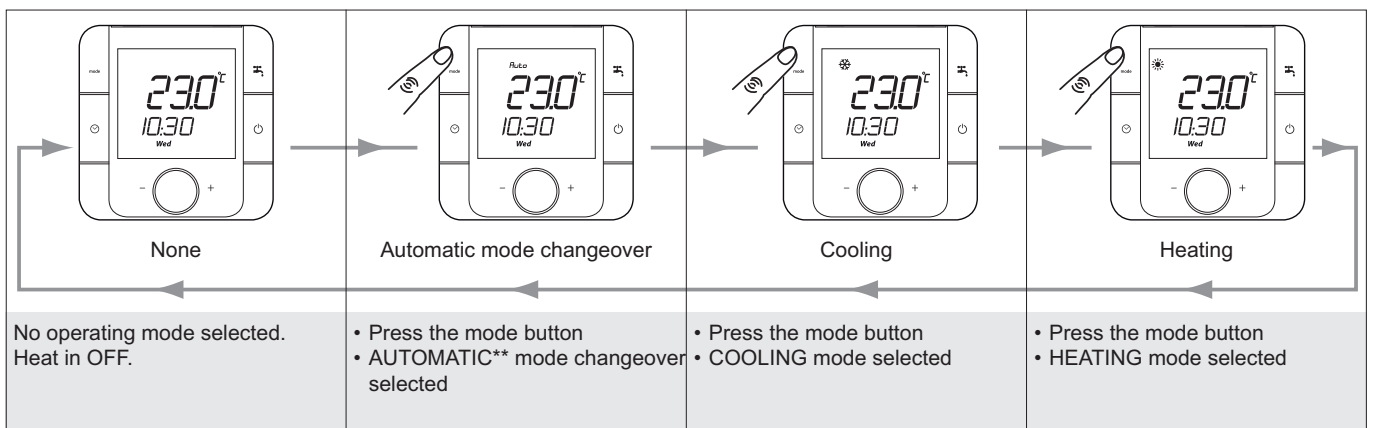

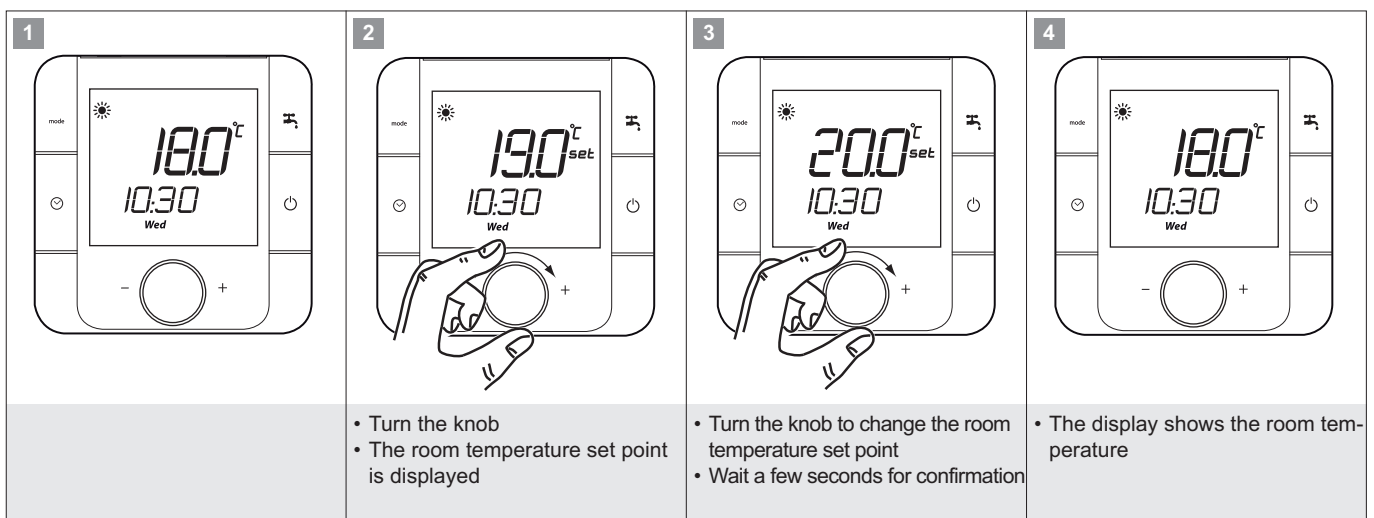

\*\* AUTO automatic mode changeover based on the outside air temperature

### Selecting the room temperature set point



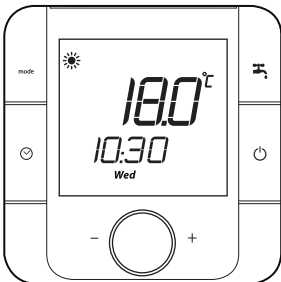
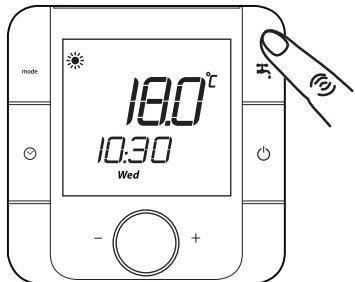
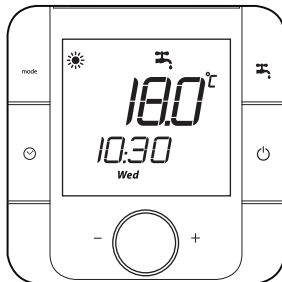



**Domestic hot water production**

<p>1</p> 	<p>2</p> 	<p>3</p> 
<p>Domestic hot water production not enabled</p>	<p>Press the .</p>	<ul style="list-style-type: none"> <li>Domestic hot water production enabled</li> <li>The  symbol is displayed</li> </ul>

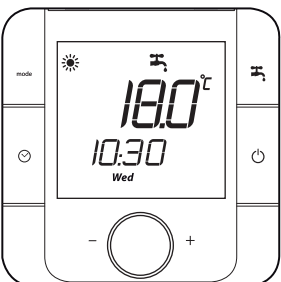
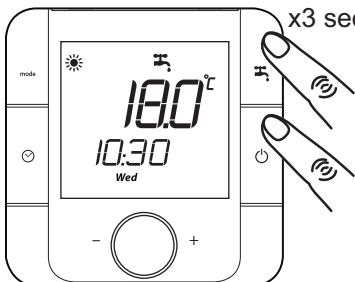
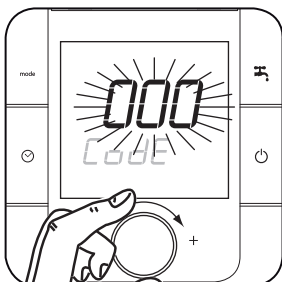
**Selecting the domestic hot water set point**

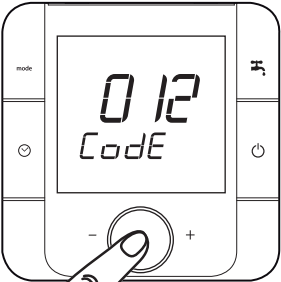
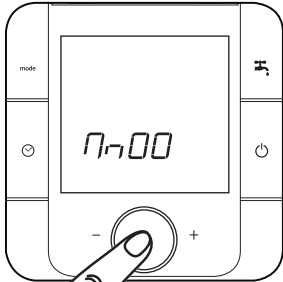
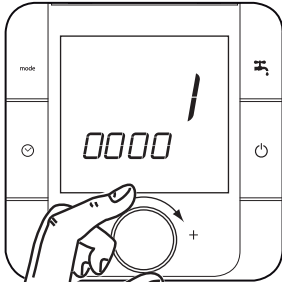
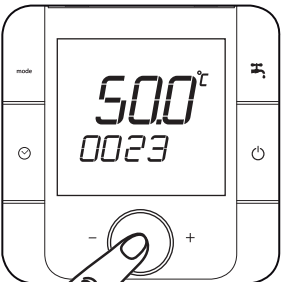
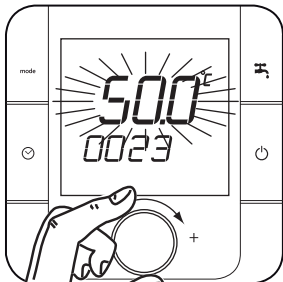
The domestic hot water temperature is measured by the probe installed inside the DHW storage tank.

<p>1</p> 	<p>2</p>  <p>x3 sec.</p>	<p>3</p> 
	<ul style="list-style-type: none"> <li>Press the  +  buttons together for 3 seconds</li> </ul>	<ul style="list-style-type: none"> <li>Turn the knob and select the value of parameter 012</li> </ul>
<p>4</p> 	<p>5</p> 	<p>6</p> 
<ul style="list-style-type: none"> <li>Press the knob to confirm</li> </ul>	<ul style="list-style-type: none"> <li>Press the knob to confirm</li> </ul>	<ul style="list-style-type: none"> <li>Turn the knob and select parameter 0023</li> </ul>
<p>7</p> 	<p>8</p> 	<p>9</p> 
<ul style="list-style-type: none"> <li>Press the knob</li> </ul>	<ul style="list-style-type: none"> <li>Turn the knob to select the domestic hot water set point</li> </ul>	<ul style="list-style-type: none"> <li>Press the knob to confirm</li> </ul>



10

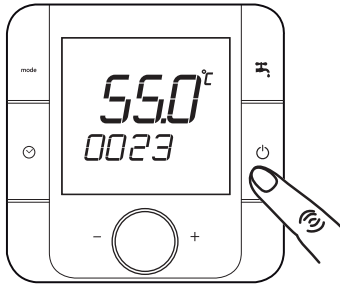

- Press the  button twice until reaching the main display.

11

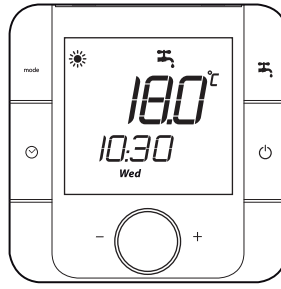

- Main display

**Programming the time bands**

The room controller can customise on/off times for each zone in the system, based on six time bands. The six time bands are identified by the following symbols, selected by turning the knob:

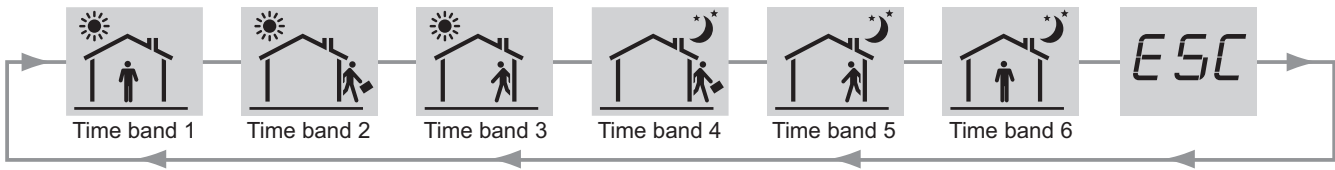

The time bands on systems with multiple zones, each of which is managed by its own room controller (maximum 6), must be programmed on each room controller.

**For installations with heap pump connected directly to the system, without storage tanks and secondary pumps, parameter 011D must be set to 0.** This means that heat pump operation will be managed based on the time bands.

<p>1</p> <p>x5 sec.</p> <p>• Press the  button for 5 seconds</p>	<p>2</p> <p>• Turn the knob</p>	<p>3</p> <p>• Press to confirm</p>
--	---------------------------------	------------------------------------

The time bands can be programmed by selecting the days in preset groups or for each individual day.

<p>4</p> <p><b>GROUP OF 7 DAYS</b> A Turn the knob B Press the knob to confirm</p>	<p>5</p> <p><b>GROUP OF 5 DAYS</b> A Turn the knob B Press the knob to confirm</p>	<p>6</p> <p><b>GROUP OF 2 DAYS</b> A Turn the knob B Press the knob to confirm</p>	<p>7</p> <p><b>INDIVIDUAL DAY</b> A Turn the knob B Press the knob to confirm</p>
--	--	--	---

<p>8</p> <p><b>Time band 1</b> • Press the knob to confirm</p>	<p>9</p> <p><b>Time band 1 start hours</b> A Turn the knob B Press the knob to confirm the hour value</p>	<p>10</p> <p><b>Time band 1 start minutes</b> A Turn the knob B Press the knob to confirm the minutes value</p>	<p>11</p> <p><b>Time band 1 room temp. set point</b> A Turn the knob B Press the knob to confirm</p>
--	---	---	--

<p>8 + 9 ... 10 ... 11</p>	<p>12</p>	<p>13</p>	<p>14</p>
<p><b>Time band 2</b></p> <ul style="list-style-type: none"> <li>• Press the knob to confirm</li> </ul> <p><b>Continue as described from step 8 to step 11 to set the hours, minutes and room temperature set point for the other time bands</b></p>	<p>Once the time bands have been set</p> <p><b>A</b> Turn the knob and select ESC <b>B</b> Press to confirm</p>	<ul style="list-style-type: none"> <li>• Press the  button twice until reaching the main display.</li> </ul>	<ul style="list-style-type: none"> <li>• Main display</li> </ul>

Press the button to exit programming mode

### Time band program example

Below is an example of a time band program with two temperature levels, Comfort 20°C, Economy 18°C, and OFF.

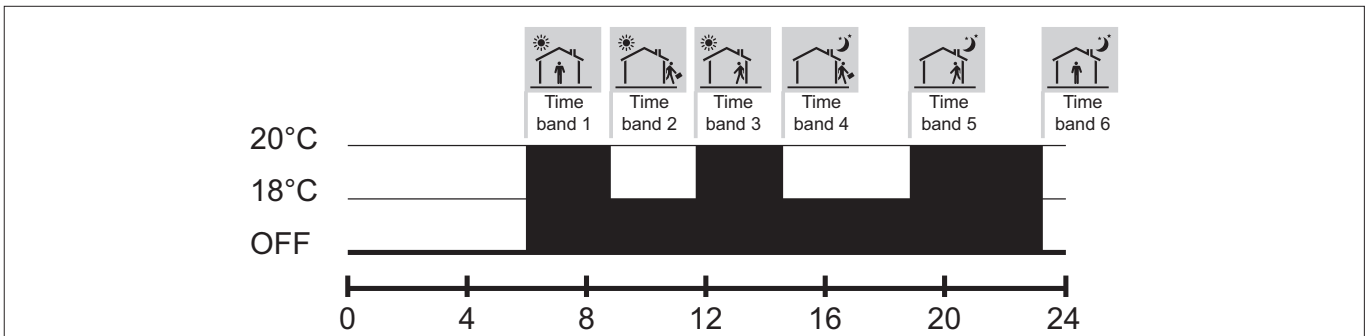

### Activating time bands



<p>1</p>	<p>2</p>
<ul style="list-style-type: none"> <li>• Press the  button.</li> </ul>	<ul style="list-style-type: none"> <li>• The  symbol is displayed</li> <li>• Time band ACTIVE</li> </ul>



### Deactivating time bands

<p>1</p>	<p>2</p>
<ul style="list-style-type: none"> <li>• Press the  button.</li> </ul>	<ul style="list-style-type: none"> <li>• The  symbol is no longer displayed</li> <li>• Time band DEACTIVATED</li> </ul>

Once the time bands have been deactivated check that the room set point is at the required value, otherwise turn the knob to select the desired temperature.

**Switching OFF**

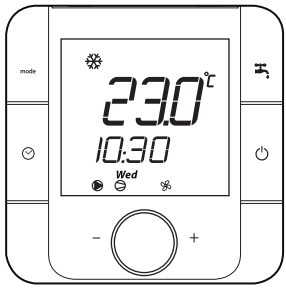
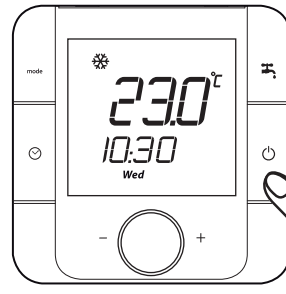
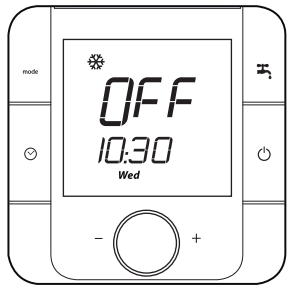
The  button disables operation of the pump or the zone valve controlled by the room controller, the heat pump is deactivated using the  button, as shown in " Selecting the operating mode".



<p>1</p> 	<p>2</p>  <p>x3 sec.</p>	<p>3</p> 
Unit ON - ZONE ON	• Press the  button for 3 seconds	Unit OFF - ZONE OFF

**ACCESSING THE PROGRAMMING LEVELS**

The room controller has a menu structure, divided into levels so as to allow access only to authorised users, as shown below:

Level	Password	Menu description	Menu code
User	012	Room unit	Mnu00
Installer	022	Zone room terminal address setting	Addr
		System configuration	Mnu01
	034	DHW	Mnu02
		Supplem. sources	Mnu03
		Cascade/Forced fan	Mnu04
		Primary and DHW exchanger	Mnu06
		input / output	Mnu09
Authorised technical service	Contact Manufacturer	Compressor	Mnu05
		Source heat exchanger	Mnu07
		Defrost	Mnu08
		Alarm log	Mnu11
		Serial protocol	Mnu12

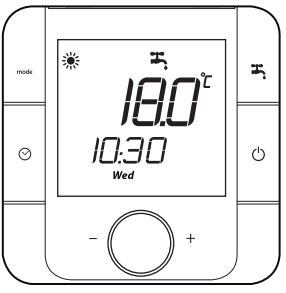
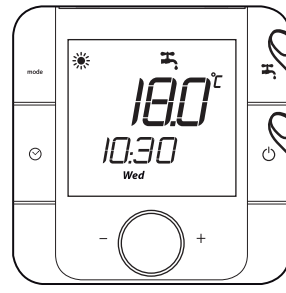
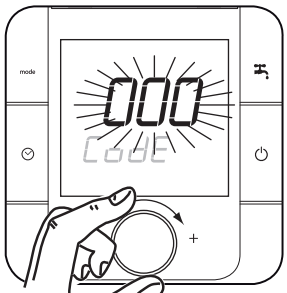
**Procedure for accessing the menu**

<p>1</p> 	<p>2</p>  <p>x3 sec.</p>	<p>3</p> 
• Main display	• Press the  +  buttons together for 3 seconds	• Turn the knob and select the password (as shown in the table)

➔

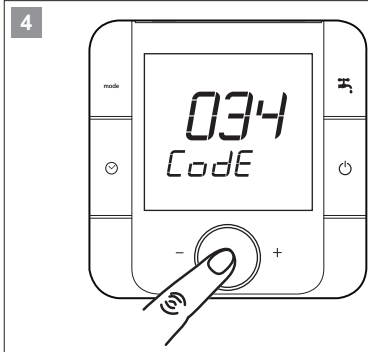

- Press the knob to confirm

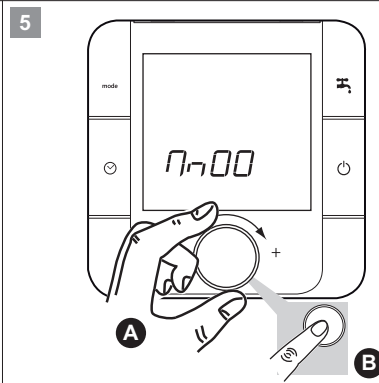

- A Turn the knob to select the menu
- B Press the knob to confirm

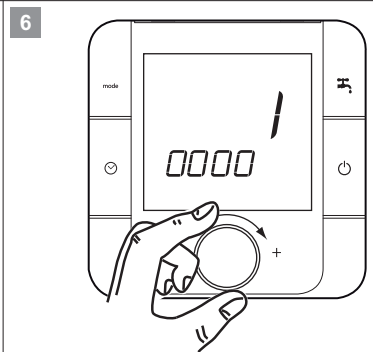

- Turn the knob and select the parameter to be set

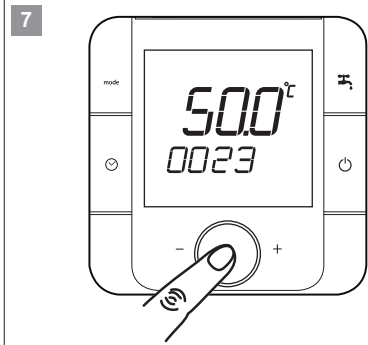

- Press the knob

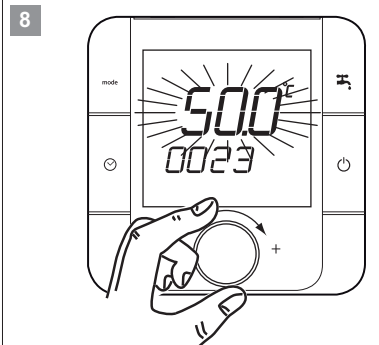

- The parameter value flashes
- Turn the knob to change the parameter value

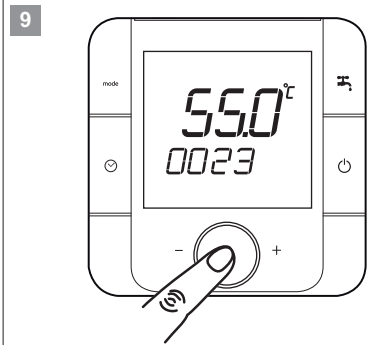

- Press the knob to confirm

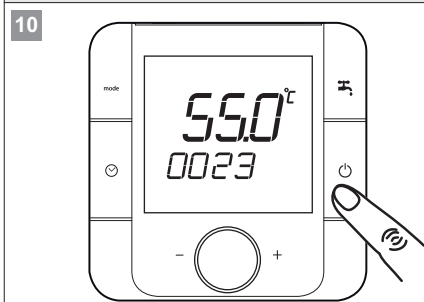

- Press the  button twice until reaching the main display

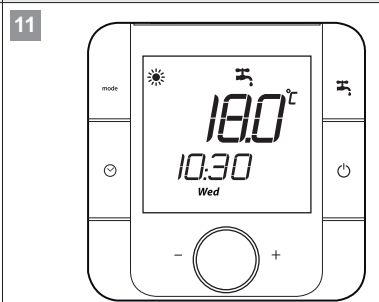

- Main display

Press the  button to exit programming mode

**Temperature control**

The heating or cooling circuit water temperature is calculated by the controller and depends on the following factors:

- A) system water set point compensation in heating or cooling (see paragraph)
- B) room temperature influence (see paragraph)
- C) minimum and maximum heating water temperature limit (see paragraph)
- D) room temperature set point

**A) System water temperature set point compensation**

The water temperature set point in heating or cooling is calculated based on the outside temperature trend according to settable curves.

**Water set point compensation diagram in HEATING**

The compensation curve in heating mode can be modified to allow correct heat pump operation depending on the heating system used (radiant panels, radiators, fan coils).

Example: Selecting heating curve 1.4 with an outside air temperature of -5°C gives a water temperature of +55°C.

A heating curve that is too high gives an excessive outlet temperature, a curve that is too low may mean the desired room temperature is not reached.

The curve can be set separately for each zone, depending on the type of room terminal.

The following compensation curves are recommended:

Type of terminal	Compensation curve number
Radiant panels	0,25÷0,7
Fan coils	0,9÷1,1
Radiators	1,2÷1,5

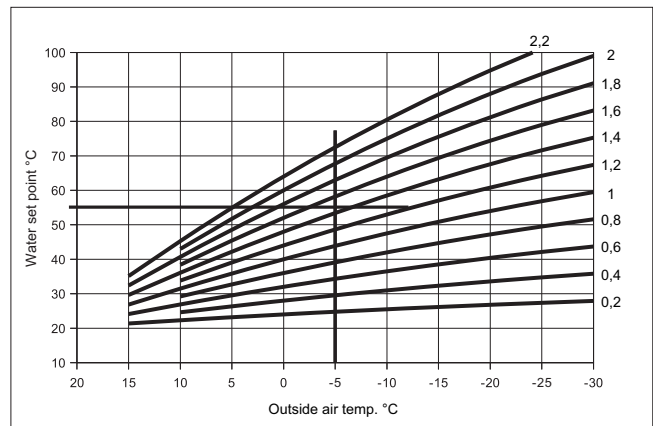

**The compensation curves in HEATING are divided into:**

- **SYSTEM curve:** determines the set point for heat pump operation and any high temperature zones. The set point calculated refers to the heat pump return water temperature. The water outlet temperature is usually 5°C higher than the return temperature. This temperature difference may change depending on the flow-rate and the type of system. Make sure that the temperature difference is within the limits required by the manufacturer.
- **ZONE curve** determines the water outlet temperature in the mixed circuit.

For systems configured with mixed zones, the SYSTEM curve and ZONE curve must be selected.

The system and zone curve work in cascading, the mixed zone curve may therefore not request a higher value than the one supplied by the system curve.

Description	Menu	Parameter no.	Default	UOM
Enable SYSTEM compensation curve 0= Disabled 1= Enabled	Mn01	0152	0	
SYSTEM compensation curve number	Mn01	0159	0,8	
Enable compensation curve zone LT1 0= Disabled 1= Enabled	Mn01	0167	0	
Compensation curve number zone LT1	Mn01	0174	0,7	
Enable compensation curve zone LT2 0= Disabled 1= Enabled	Mn01	0182	0	
Compensation curve number zone LT2	Mn01	0189	0,7	
Enable compensation curve zone LT3 0= Disabled 1= Enabled	Mn01	015E	0	
Compensation curve number zone LT3	Mn01	012A	0,7	



**B) Room temperature influence in HEATING**

The compensation curve determines the heating water temperature; this may then be corrected based on the difference between the desired room set point and the actual room temperature.

The correction made to the water temperature depends on the “Room Authority” coefficient.

The higher the value of the Room Authority the higher the correction to the system water temperature, and vice-versa.

This allows the water temperature to adapt quickly to changes in the conditions inside the room.

The function can only be ENABLED if the A5 room controller is positioned in the room and used to measure the reference temperature.

Set authority values for the SYSTEM equal to or greater than those for zones LT1, LT2, LT3.

Enabling room temperature influence on SYSTEM deviates the calculated heat pump return water temperature set point.

Enabling room temperature influence on ZONE LT1, LT2, LT3 deviates the calculated water outlet temperature set point to the system, controlled by the mixing valve.

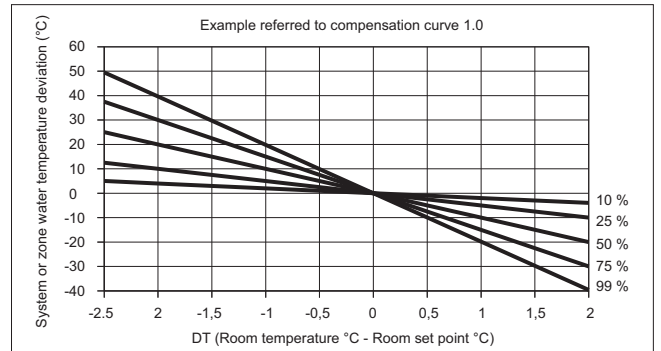

Description	Menu	Parameter no.	Default	UOM
Enable room temperature influence on SYSTEM 0= Disabled 1= Enabled	Mn01	0162	0	
SYSTEM Room Authority	Mn01	0164	30	%
Enable Room temperature influence on LT1 0= Disabled 1= Enabled	Mn01	0178	0	
LT1 Room Authority	Mn01	0179	30	%
Enable Room temperature influence on LT2 0= Disabled 1= Enabled	Mn01	0193	0	
LT2 Room Authority	Mn01	0194	30	%
Enable Room temperature influence on LT3 0= Disabled 1= Enabled	Mn01	012D	0	
LT3 Room Authority	Mn01	012E	30	%

**C) System water temperature limits in HEATING**

These define the temperature limits (minimum and maximum) that can be requested from the circuit and never exceeded.

In the figure the minimum limit is 30°C and the maximum is 40°.

Between 30 and 40°C the water temperature will be able to vary based on the trend in outside temperature.

For systems configured with mixed zones, the limits for the SYSTEM curve and ZONE curve must be selected.

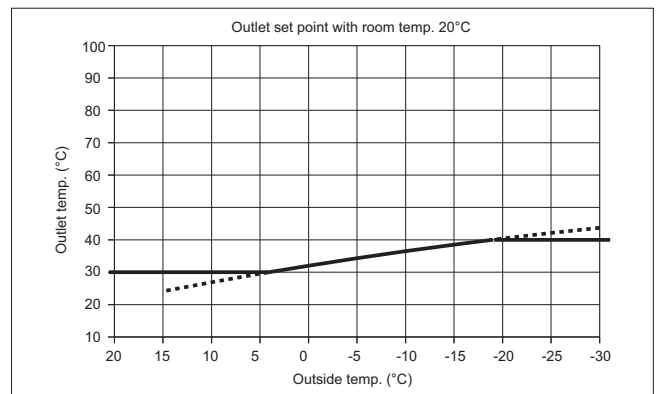

Description	Menu	Parameter no.	Default	UOM
MINIMUM set point limit for SYSTEM curve	Mn01	0165	30	°C
MAXIMUM set point limit for SYSTEM curve	Mn01	0166	48	°C
MINIMUM outlet set point limit for compensation curve in zone LT1	Mn01	0180	23	°C
MAXIMUM outlet set point limit for compensation curve in zone LT1	Mn01	0181	45	°C
MINIMUM outlet set point limit for compensation curve in zone LT2	Mn01	0195	23	°C
MAXIMUM outlet set point limit for compensation curve in zone LT2	Mn01	0196	45	°C
MINIMUM outlet set point limit for compensation curve in zone LT3	Mn01	012F	23	°C
MAXIMUM outlet set point limit for compensation curve in zone LT3	Mn01	012G	45	°C

**Water set point compensation diagram in COOLING**

The compensation curve in cooling mode can be modified to allow correct heat pump operation depending on the cooling system used (radiant panels, fan coils).

Points T1 and T2 correspond to two outside temperature values that respectively identify the maximum and minimum system water temperature.

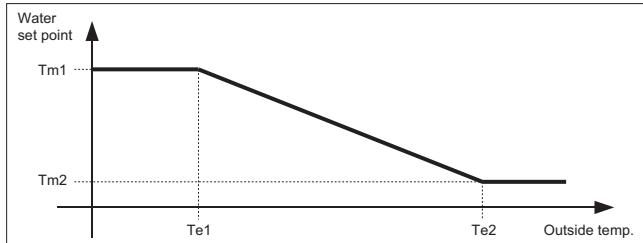

**The compensation curves in COOLING are divided into:**

- **SYSTEM curve:** determines the set point for heat pump operation and any high temperature zones. The set point calculated refers to the heat pump return water temperature. The water outlet temperature is usually 5°C lower than the return temperature. This temperature difference may change depending on the flow-rate and the type of system. Make sure that the temperature difference is within the limits required by the manufacturer.
- **ZONE curve** determines the water outlet temperature in the mixed circuit.

For systems configured with mixed zones, the SYSTEM curve and ZONE curve must be selected.

The system and zone curve work in cascading, the mixed zone curve may therefore not request a higher value than the one supplied by the system curve.

**Maximum room humidity compensation**

The water temperature set point, calculated based on the compensation curve, can be compensated according to the maximum relative humidity in the room.

The water temperature value can increase so as to avoid possible formation of condensate in the radiant cooling systems (underfloor, ceiling, wall, etc.).

If the relative humidity measured by the A5 room unit A5 exceeds the value set for parameter 0157, 0172, 0187, the water temperature set point increases until reaching the maximum temperature.

The maximum water temperature is the set point calculated according to the compensation curve in cooling mode plus the value set for parameter 0158, 0173, 0188.

Enabling room humidity compensation on SYSTEM deviates the calculated heat pump return water temperature set point.

Enabling room humidity compensation on ZONE LT1, LT2, LT3 deviates the calculated water outlet temperature set point to the system, controlled by the mixing valve.

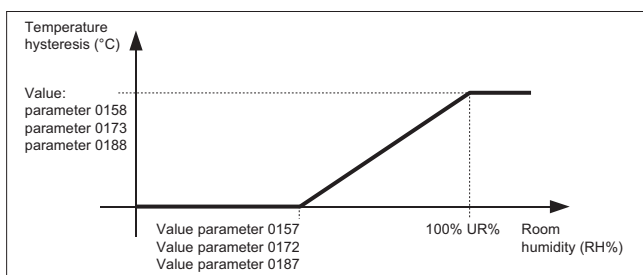

Description	Menu	Parameter no.	Default	UOM
Enable SYSTEM compensation curve 0= Disabled 1= Enabled	Mn01	0154	0	
Maximum return temperature set point limit in cooling mode (Tm1)	Mn01	0128	25	°C
Minimum outside temperature corresponding to max. return temperature (Te1)	Mn01	0129	23	°C
Minimum return temperature set point limit in cooling mode (Tm2)	Mn01	0130	23	°C
Maximum outside temperature corresponding to min. return temperature (Te2)	Mn01	0131	36	°C
Enable compensation curve zone LT1 0= Disabled 1= Enabled	Mn01	0169	0	
Maximum outlet temperature set point limit in cooling mode (Tm1)	Mn01	0132	20	°C
Minimum outside temperature corresponding to max. outlet temperature (Te1)	Mn01	0133	23	°C
Minimum outlet temperature set point limit in cooling mode (Tm2)	Mn01	0134	18	°C
Maximum outside temperature corresponding to min. outlet temperature (Te2)	Mn01	0135	36	°C
Enable compensation curve zone LT2 0= Disabled 1= Enabled	Mn01	0184	0	
Maximum outlet temperature set point limit in cooling mode (Tm1)	Mn01	0136	20	°C
Minimum outside temperature corresponding to max. outlet temperature (Te1)	Mn01	0137	23	°C
Minimum outlet temperature set point limit in cooling mode (Tm2)	Mn01	0138	18	°C
Maximum outside temperature corresponding to min. outlet temperature (Te2)	Mn01	0139	36	°C
Enable compensation curve zone LT3 0= Disabled 1= Enabled	Mn01	011T	0	
Maximum outlet temperature set point limit in cooling mode (Tm1)	Mn01	012H	20	°C
Minimum outside temperature corresponding to max. outlet temperature (Te1)	Mn01	012J	23	°C
Minimum outlet temperature set point limit in cooling mode (Tm2)	Mn01	012L	18	°C
Maximum outside temperature corresponding to min. outlet temperature (Te2)	Mn01	012M	36	°C

Description	Menu	Parameter no.	Default	UOM
Enable compensation for room humidity, SYSTEM 0= Disabled 1= Enabled	Mn01	0156	0	
Room relative humidity value to start increasing SYSTEM water return temperature set point	Mn01	0157	70	%
Maximum return temperature hysteresis corresponding to 100% relative humidity	Mn01	0158	15	°C
Enable compensation for room humidity, ZONE LT1 0= Disabled 1= Enabled	Mn01	0171	0	
Room relative humidity value to start increasing water outlet temperature set point ZONE LT1	Mn01	0172	70	%
Maximum outlet temperature hysteresis corresponding to 100% relative humidity	Mn01	0173	15	°C
Enable compensation for room humidity, ZONE LT2 0= Disabled 1= Enabled	Mn01	0186	0	
Room relative humidity value to start increasing water outlet temperature set point ZONE LT2	Mn01	0187	70	%
Maximum outlet temperature hysteresis corresponding to 100% relative humidity	Mn01	0188	15	°C
Enable compensation for room humidity, ZONE LT3 0= Disabled 1= Enabled	Mn01	012N	0	
Room relative humidity value to start increasing water outlet temperature set point ZONE LT2	Mn01	012P	70	%
Maximum outlet temperature hysteresis corresponding to 100% relative humidity	Mn01	012R	15	°C

## Automatic mode changeover based on outside temperature

In *Auto* mode, the operating mode (heating / cooling) changes automatically, avoiding the need for the user to change the mode manually.

Mode changeover is based on the diagram shown in the figure.

The centre zone A corresponds to an area of inactivity, as the outside climate conditions mean neither heating nor cooling is required.

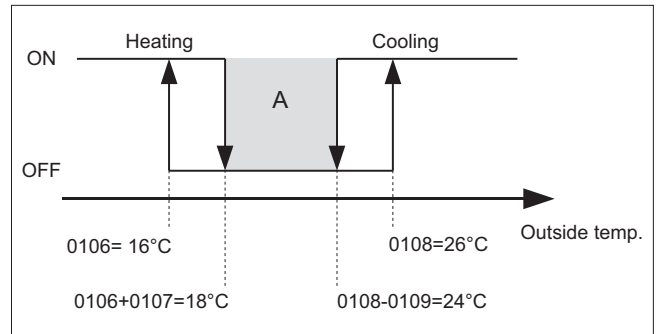
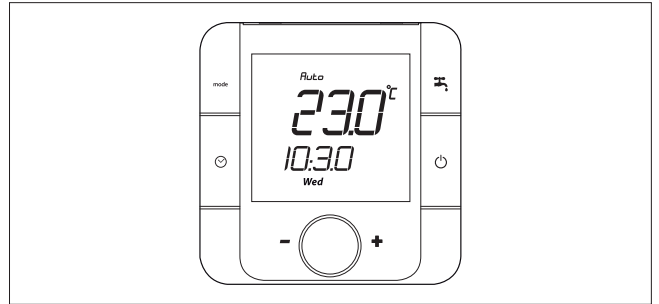

Description	Menu	Parameter no.	Default	UOM
Automatic mode changeover set point in HEATING	Mn01	0106	16	°C
Automatic mode changeover differential in HEATING	Mn01	0107	2	°C
Automatic mode changeover set point in COOLING	Mn01	0108	24	°C
Automatic mode changeover differential in COOLING	Mn01	0109	2	°C

## System pump operation

When reaching the system water set point, the compressor stops and the system pump is activated periodically, so as to minimise energy consumption.

Pump operating time can be selected using parameter 0147, while the interval between one sniffing cycle and the next is set using parameter 0148.

Intermittent activation of system pump operation can be selected using parameter 0143 (0= system pump always on to, 1=system pump activated at intervals).

In systems with fan coils, the time between one sniffing cycle and the next should be reduced in order to avoid cooling excessive of the water, and if the system water content is equal to the minimum value shown in the paragraph on "water connections", parameter 0143 should be set to 0.

**Heat pump operation with fixed set point**

System water set point compensation using the compensation curves can be disabled.

To enable fixed set point operation, set parameter 0152=0 and 0154=0

The heat pump will operate based on the fixed return set point defined by parameters 0153 (Heating) and 0155 (cooling).

Description	Menu	Parameter no.	Default	UOM
Enable return set point in HEATING 0= Fixed set point in heating ENABLED 1= Fixed set point in heating DISABLED	Mn01	0152	0	-
Fixed return water temperature set point in HEATING	Mn01	0153	40	°C
Enable return set point in COOLING 0= Fixed set point in cooling ENABLED 1= Fixed set point in cooling DISABLED	Mn01	0154	0	-
Fixed return water temperature set point in COOLING	Mn01	0155	12	°C

**FROST PROTECTION**

**Frost protection based on system water temperature**

The frost protection function is active even if the controller is in standby. To prevent the water freezing and damaging the plate heat exchanger, the microprocessor shuts down the compressor and activates the system heat exchanger heater if the temperature measured by the heat exchanger outlet temperature probe is than +4°C. The frost prevention temperature set point can only be modified by an authorised service centre, and only after verifying that the water circuit contains antifreeze. Tripping of this alarm shuts down the compressor but not the pump, which remains active.

To reset normal operation, the water outlet temperature must rise to more than: +7°C on the system side. Reset is automatic.

**Frost protection based on inside temperature**

Frost protection on the heating circuit is always active, even when the heat pump is off.

The heat pump and/or supplementary sources of heat (outlet heater or boiler) are activated if the room temperature falls below the value set for parameter 0140, to prevent the pipes inside the home from freezing.

Description	Menu	Parameter no.	Default	UOM
Inside temperature to enable frost protection	Mn01	0140	14	°C

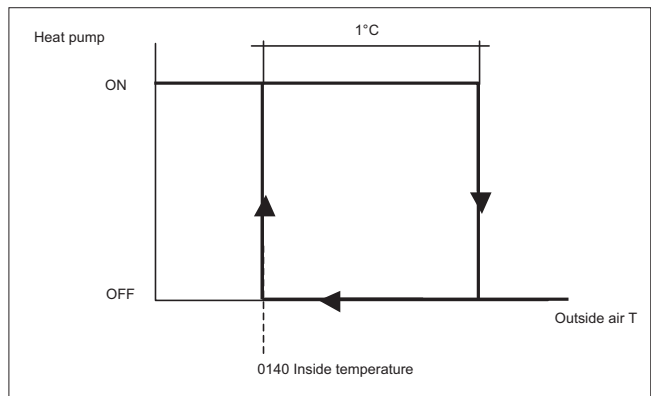

**Frost protection based on outside air temperature**

Frost protection on the heating and domestic hot water circuits based on outside air temperature is always active, even when the heat pump is off.

The system and domestic hot water pumps are activated when the outside air temperature falls below the value set for parameter 0141.

Description	Menu	Parameter no.	Default	UOM
Outside temperature to enable frost protection	Mn01	0141	4	°C

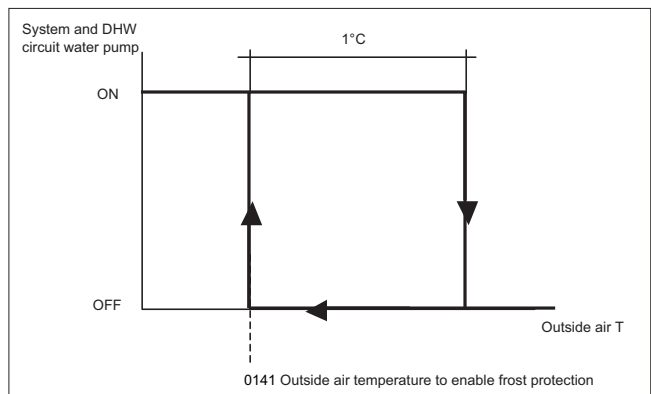

Il controllore della pompa di calore permette la configurazione di 15 differenti tipologie di impianto selezionabili impostando il parametro 0101.

La tabella seguente riporta gli impianti configurabili.

Menu	Parameter 0101	Mixed zone 1	Mixed zone 2	Mixed zone 3	High temperature zone 1 (fan coils / radiators)	High temperature zone 2 (fan coils / radiators)	High temperature zone 3 (fan coils / radiators)	DHW recirculation	N-EM1 expansion module
									n°
Mn01	0				X				0
Mn01	1				X			X	1
Mn01	2	X							1
Mn01	3	X			X				1
Mn01	4	X			X			X	2
Mn01	5	X			X	X			2
Mn01	6	X			X	X		X	2
Mn01	7	X			X	X	X		2
Mn01	8	X			X	X	X	X	2
Mn01	9	X	X						2
Mn01	10	X	X					X	2
Mn01	11	X	X		X			X	2
Mn01	12	X	X		X	X		X	3
Mn01	13	X	X		X	X	X	X	3
Mn01	14	X	X	X				X	3

Configuration 0 does NOT require additional expansion modules

Configurations from 1 to 3 require 1 additional N-EM1 expansion module

Configurations from 4 to 11 require 2 additional N-EM1 expansion modules

Configurations 12, 13 and 14 require 3 additional N-EM1 expansion modules

The water connection and wiring diagrams for configurations from 1 to 14 are shown on the instruction sheet enclosed with the N-EM1 expansion module.

The parameters required for correct system operation can be set on the A5 room controller supplied with the heat pump.

The next few pages are divided into the following sections:

Section 1 WATER CIRCUIT DIAGRAM

Section 2 WIRING DIAGRAM

Section 3 PARAMETER CONFIGURATION

Heat pump connection to the system without low-loss header. Make sure the useful pressure head of the circulating pump on the unit is sufficient for the pressure drop in the system. If the minimum system content does not reach values shown in this manual, install an additional storage tank on the heat pump return pipe. No system configurations are required.

Water circuit diagram

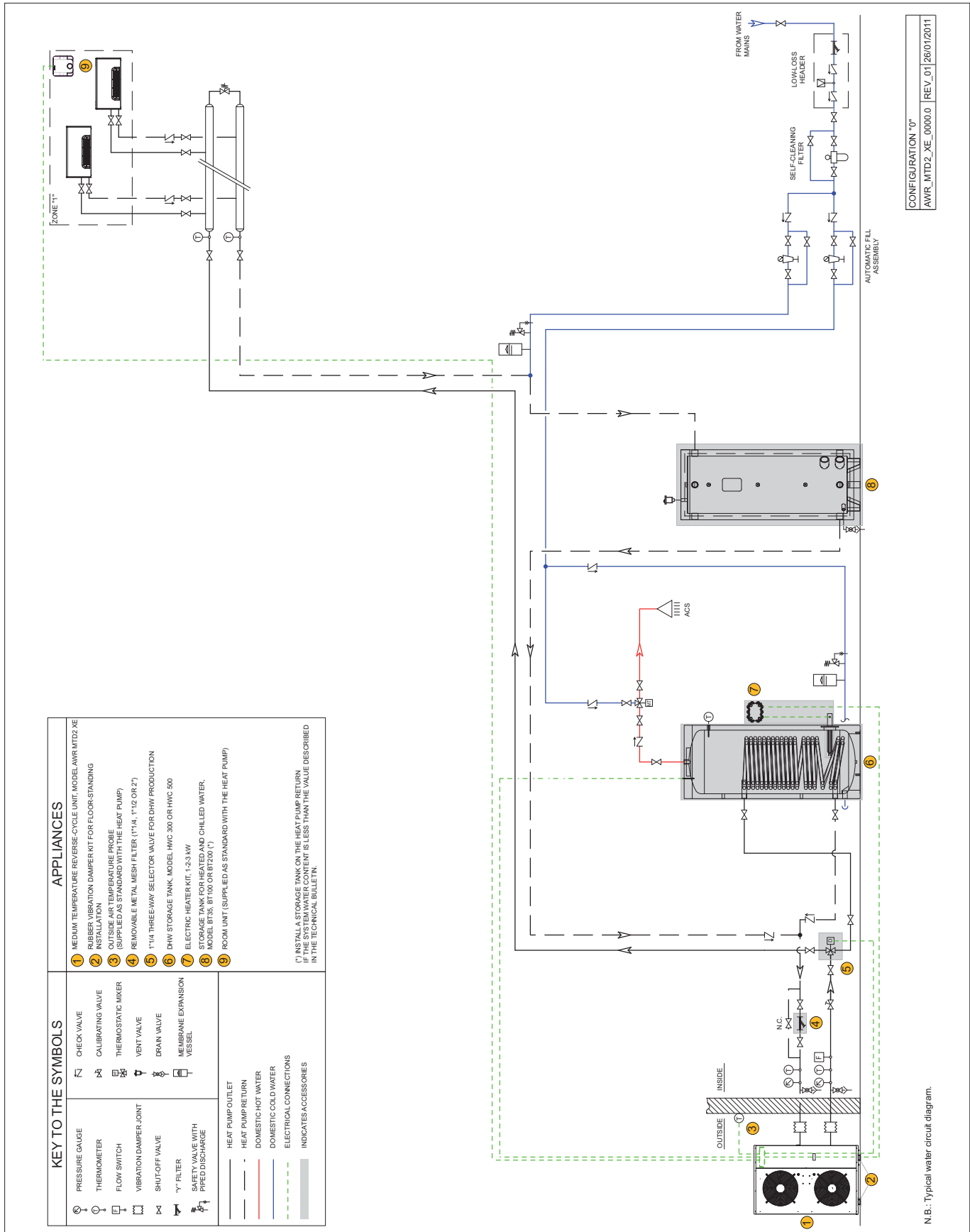

CONFIGURATION "0"  
AWR\_MTD2\_XE\_00000\_0 | REV\_01 | 26/01/2011

## Parameter configuration

Description	Menu	Parameter no.	Default	Write set value	UOM
<b>SYSTEM compensation curves in heating mode</b>					
Enable SYSTEM compensation curve 0= Disabled 1= Enabled	Mn01	0152	0		-
SYSTEM compensation curve number	Mn01	0159	1		-
Enable room temperature influence on SYSTEM 0= Disabled 1= Enabled	Mn01	0163	0		-
SYSTEM Room Authority	Mn01	0164	30		%
MINIMUM return set point limit for SYSTEM curve	Mn01	0165	30		°C
MAXIMUM return set point limit for SYSTEM curve	Mn01	0166	48		°C
<b>SYSTEM compensation curves in cooling mode</b>					
Enable SYSTEM compensation curve 0= Disabled 1= Enabled	Mn01	0154	0		-
Maximum return temperature set point limit in cooling mode (Tm1)	Mn01	0128	25		°C
Minimum outside temperature corresponding to max. return temperature (Te1)	Mn01	0129	23		°C
Minimum return temperature set point limit in cooling mode (Tm2)	Mn01	0130	23		°C
Maximum outside temperature corresponding to min. return temperature (Te2)	Mn01	0131	36		°C

System number 0

Water circuit diagram

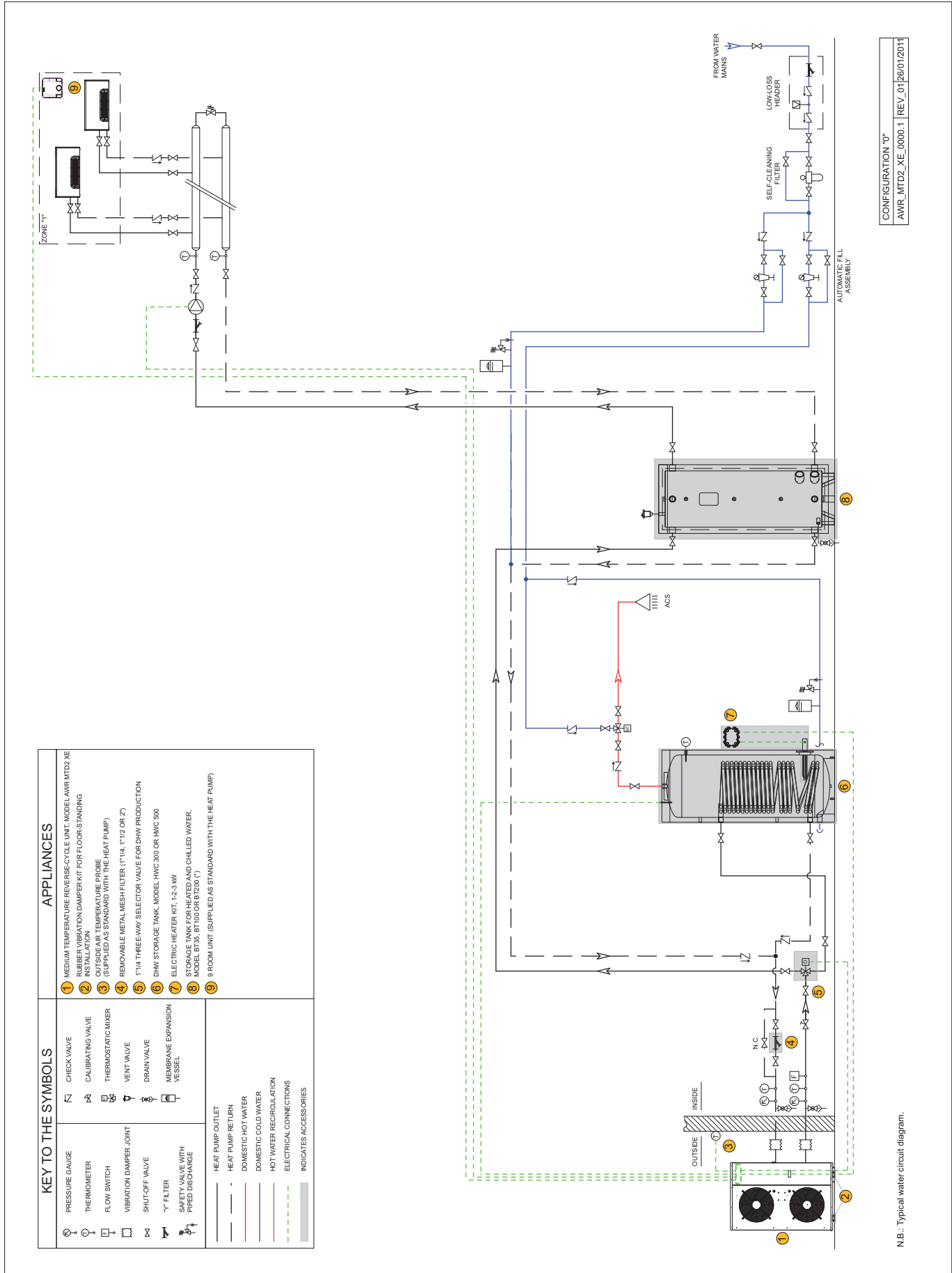

CONFIGURATION "0"  
AWR\_MTD2\_XE\_0000.1 | REV. 01 | 26/01/2011

N.B.: Typical water circuit diagram.



System number 0

Wiring diagram

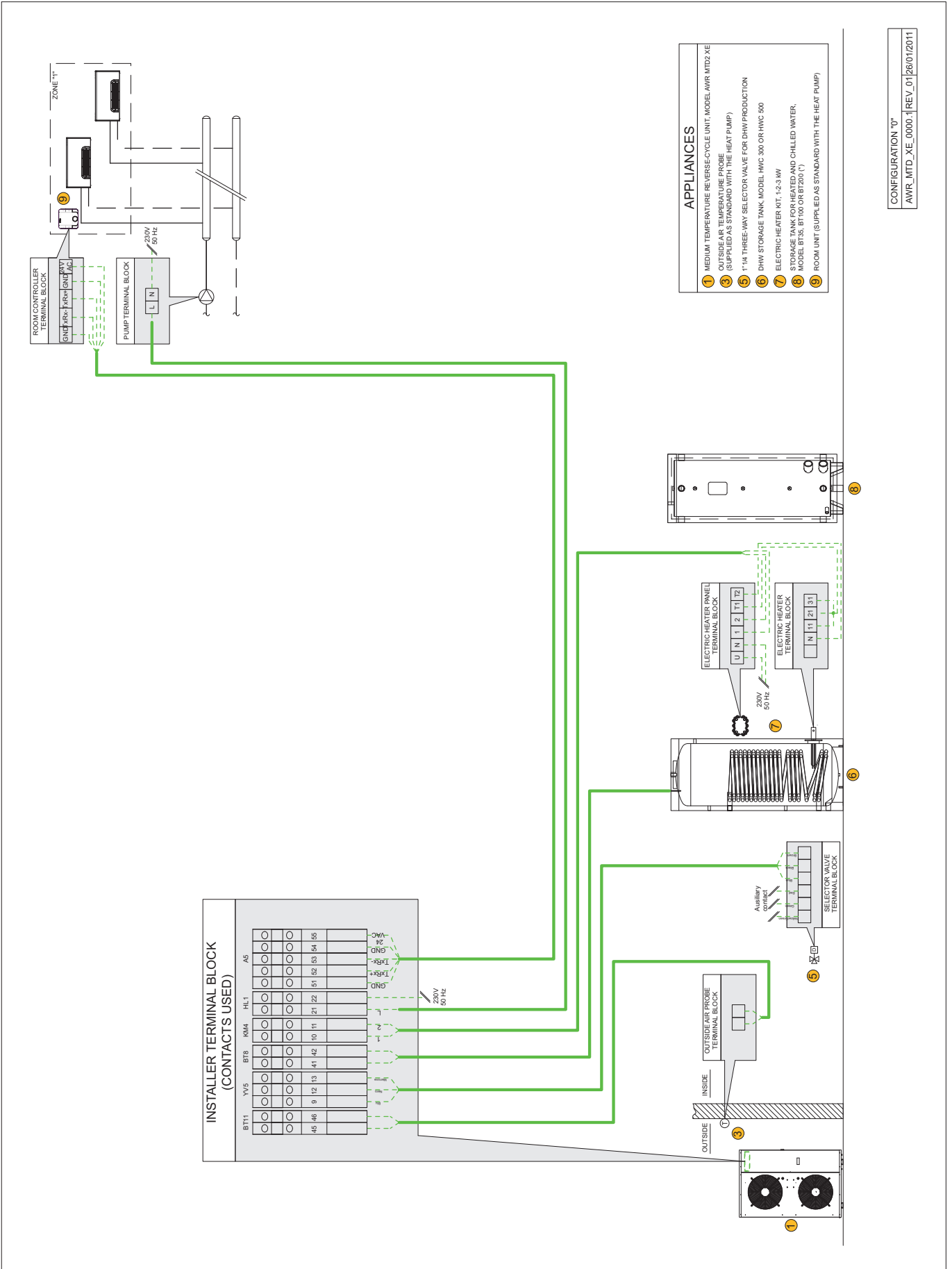

CONFIGURATION "0"  
AWR\_MTD\_XE\_0000 | REV\_01 | 26/01/2011

## System number 0

## Parameter configuration

Description	Menu	Parameter no.	Default	Write set value	UOM
System type (table 1)	Mn01	0101	0	0*	-
<b>SYSTEM compensation curves in heating mode</b>					
Enable SYSTEM compensation curve 0= Disabled 1= Enabled	Mn01	0152	0		-
SYSTEM compensation curve number	Mn01	0159	1		-
Enable room temperature influence on SYSTEM 0= Disabled 1= Enabled	Mn01	0163	0		-
SYSTEM Room Authority	Mn01	0164	30		%
MINIMUM return set point limit for SYSTEM curve	Mn01	0165	30		°C
MAXIMUM return set point limit for SYSTEM curve	Mn01	0166	48		°C
<b>SYSTEM compensation curves in cooling mode</b>					
Enable SYSTEM compensation curve 0= Disabled 1= Enabled	Mn01	0154	0		-
Maximum return temperature set point limit in cooling mode (Tm1)	Mn01	0128	25		°C
Minimum outside temperature corresponding to max. return temperature (Te1)	Mn01	0129	23		°C
Minimum return temperature set point limit in cooling mode (Tm2)	Mn01	0130	23		°C
Maximum outside temperature corresponding to min. return temperature (Te2)	Mn01	0131	36		°C
<b>Contact HL1 configuration, secondary circuit pump</b>					
Enable contact HL1 HIGH TEMPERATURE ZONE (The contact closes and the pump or motor-driven shut-off valve is activated)	Mn01	015A	0	3*	

\* obligatory values for the present configuration

### Alarm signals

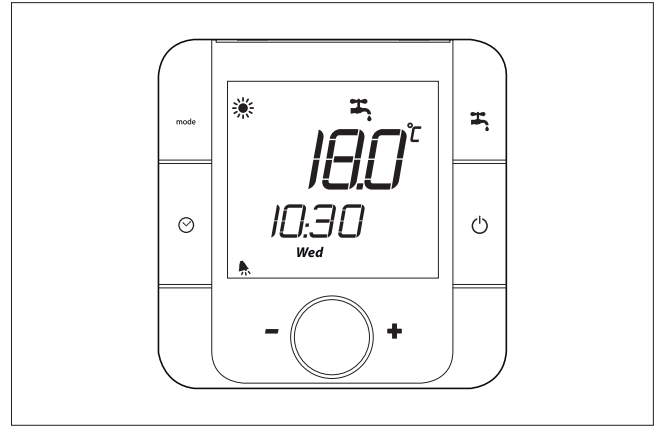

When an alarm is activated, the  symbol comes on.



### Displaying alarms

<p><b>1</b></p> <p>x3 sec.</p> <ul style="list-style-type: none"> <li>• Press the  and <b>mode</b> buttons for 3 seconds</li> </ul>	<p><b>2</b></p> <ul style="list-style-type: none"> <li>• Turn the knob</li> <li>• Display the alarm codes</li> </ul>	<p><b>3</b></p> <ul style="list-style-type: none"> <li>• Press the knob to confirm</li> <li>• Resolve the problem and then reset the alarms using the procedure described in "Resetting alarms"</li> </ul>
--	--	--

### Resetting alarms

<p><b>1</b></p> <p>x3 sec.</p> <ul style="list-style-type: none"> <li>• Press the  and <b>mode</b> buttons for 3 seconds</li> </ul>	<p><b>2</b></p> <ul style="list-style-type: none"> <li>• Turn the knob</li> <li>• Select </li> </ul>	<p><b>3</b></p> <ul style="list-style-type: none"> <li>• Press the knob to confirm</li> <li>• Alarms reset</li> </ul>
--	---	---

### Alarm log

The alarm log can only be displayed using the service keypad. Contact an authorised service centre.

The room controller can display the most recently activated alarm code from Mn11:

- parameter 1100 = no. of alarms saved in the log (visible only with service keypad)
- parameter 1101= code of last alarm activated

- parameter 1102= alarm activation hour
- parameter 1103= alarm activation minutes
- parameter 1104= alarm activation day
- parameter 1105= alarm activation month
- parameter 1106= alarm activation year

**ALARM TABLE**

Alarm code	Cause	Solution
A001	BT1 System heat exchanger water inlet temperature probe	Probe faulty or disconnected
A002	BT2 System heat exchanger water outlet temperature probe	Probe faulty or disconnected
A003	BT8 DHW storage temperature probe	Probe faulty or disconnected
A004	BT7 Outside air temperature probe for unit management	Probe faulty or disconnected
A005	BT9 Storage tank temperature probe	Probe faulty or disconnected
A006	BT11 Outside air temperature probe	Probe faulty or disconnected
A007	BP1 High pressure transducer	Transducer faulty or disconnected
A013	F1 High pressure switch	Check connection Check refrigerant circuit pressure
A014	High pressure measured by transducer BP1	
A019	Difference between low and high pressure in refrigerant circuit too low	Check refrigerant circuit pressure Check refrigerant charge
A022	Operation outside of limits	Make sure outside air temperature and water temperature set point are inside the specified operating limits
A023	Source differential pressure switch/flow switch activated	Make sure the filter is clean Make sure the system is filled with water Check water flow-rate
A025	Differential pressure switch / system flow switch F3 activated	Make sure filters are clean Check water flow Check for air in the system
A030	Compressor operating hours reached	Scheduled maintenance
A033	System pump operating hours reached	Scheduled maintenance
A034	Domestic hot water pump operating hours reached	Scheduled maintenance
A035	Mixed zone pump operating hours reached	Scheduled maintenance
A036	Fan operating hours reached	Scheduled maintenance
A038	System heat exchanger frost prevention alarm	Scheduled maintenance
A041	DHW storage temperature too high	
A042	Inside frost prevention alarm	
A045	Outside air temperature probe	Check connections Faulty probes, replace terminal
A047		
A048		
A049		
A050	Thermostatic valve driver	Contact service centre
A051		
A052		
A053		
A054	Legionella prevention alarm	
A055	Temperature probe N-THC n.1	Check connections Probe faulty or disconnected
A056	Address setting error on remote terminal supplied with the unit	Check connections Check address
A057	Address setting error on expansion module 2	Check connections Check address, must be 1
A058	Temperature probe in low temperature zone LT2, expansion 2	Probe faulty or disconnected
A063	Address setting error on expansion module 3	Check connections Check address, must be 2
A064	Temperature probe in low temperature zone LT3, expansion 3	Probe faulty or disconnected
A075	Water temperature too high in mixed circuit, expansion module 1	
A077	Water temperature too high in mixed circuit, expansion module 2	
A094	End defrost due to maximum time	
A095	Temperature probe N-THC n.2	Check connections Probe faulty or disconnected
A096	Address setting error on zone remote terminal	Check connections Check address
A097	Temperature probe N-THC n.3	Check connections Probe faulty or disconnected
A098	Address setting error on zone remote terminal	Check connections Check address
A099	Temperature probe N-THC n.4	Check connections Probe faulty or disconnected
A100	Address setting error on zone remote terminal	Check connections Check address
A101	Temperature probe N-THC n.5	Check connections Probe faulty or disconnected
A102	Address setting error on zone remote terminal	Check connections Check address
A103	Address setting error on expansion module 1	Check connections Check address, must be 1
A104	Low temperature zone LT1 temperature probe, expansion 1	Probe faulty or disconnected
A109	Low pressure alarm from low pressure switch	Check connection Check refrigerant circuit pressure
A114	Solar/pool module address setting error	Check connections Check address
A115	Solar/pool module general alarm	
A116	Master unit not connected, cascade control	
A117	Slave unit not connected, cascade control	
A120	Water temperature too high in mixed circuit, expansion module, expansion module 3	
A121	Temperature probe N-THC n.6	Check connections Probe faulty or disconnected
A122	Address setting error on zone LT3 remote terminal	Check connections Check address

**ALARM TABLE**

Alarm code	Cause	Solution
A124	Humidity probe N-THC n.1	Check connections Probe faulty or disconnected
A125	Humidity probe N-THC n.2	Check connections Probe faulty or disconnected
A126	Humidity probe N-THC n.3	Check connections Probe faulty or disconnected
A127	Humidity probe N-THC n.4	Check connections Probe faulty or disconnected
A128	Humidity probe N-THC n.5	Check connections Probe faulty or disconnected
A129	Humidity probe N-THC n.6	Check connections Probe faulty or disconnected

**PEAK LIMITER ALARM SIGNALS**

The heat pumps can be fitted with a single-phase or three-phase peak limiter to reduce compressor start-up current.

**Peak limiter single-phase**

The LED on the peak limiter identifies different operating or alarm conditions based on the sequence of flashes:

- 2 flashes every 5 sec.: line voltage present, correct operation
- LED on for 5 sec. and LED off for 5 sec.: peak limiter faulty
- quick flashes for 10 sec.: line voltage out-of-range

**SYSTEM emergency operation**

If the heat pump is not working correctly or the compressor has shut down, emergency operation can be activated.

Emergency operation involves heating the water using the electric heaters available on the system (outlet, storage tank).

The compressor remains off.

To enable manual operation of system heaters, set parameter 0620 = 1 (manual)

Description	Menu	Parameter no.	Default	UOM
Type of outlet electric heater operation 0 = Supplementary 1 = Replacement	Mn01	010G	1	
Enable manual heater operation	Mn06	0620	1	

**Set the parameters following the sequence described in the table**

**DOMESTIC HOT WATER emergency operation**

If the heat pump is not working correctly or the compressor has shut down, emergency operation can be activated.

Emergency operation involves heating the domestic hot water using the electric heater inside the storage tank.

To enable manual operation of DHW storage heaters, set parameter 0202 = 1

Description	Menu	Parameter no.	Valore da impostare	UOM
Electric heater operating mode 0 = heat pump only 1 = electric heater only 2 = heat pump + electric heater	Mn02	0202	1	

**SHUTTING DOWN FOR LONG PERIODS**

After deactivating the heat pump:

- Disconnect the unit from the power supply.
- Make sure the remote keypad is in the "OFF" position.
- Place QF1 in the OFF position (see wiring diagram).
- Deactivate the indoor terminal units by placing the switch of each unit in the "OFF" position.
- Close the water valves.

**⚠ If the outside temperature** may fall below zero; there is the risk of freezing.  
The water circuit **MUST BE EMPTIED AND CLOSED** (if draining after operation in heat pump mode, beware that

the water may be hot), or antifreeze must be added in the proportion recommended by the manufacturer.

It is recommended to use non-toxic food grade antifreeze, compliant with the standards in force in the countries where the unit is used, if domestic hot water production is also featured.

**If the mains switch** is turned to "off" for more than four hours, after turning it on and before reactivating the unit, leave the power on but the unit deactivated for at least two hours to preheat the oil in the compressor sump.

**SCHEDULED MAINTENANCE**

**Never perform any cleaning operations** before having disconnected the unit from the mains power supply.

Make sure power is not connected before proceeding.

Control maintenance is fundamental to maintain the efficiency of the unit both in terms of operation and energy consumption.

The Technical Service maintenance plan must be observed, with an annual service which includes the following operations and checks:

- Filling of the water circuit;
- Presence of air bubbles in the water circuit;
- Efficiency of safety devices;
- Power supply voltage;
- Electrical power input;
- Tightness of electrical and water connections;

- Condition of the compressor contactor;
- Efficiency of the plate heat exchanger resistor;
- Verification of operating pressure, superheating and sub-cooling
- Efficiency of the compressor heater
- Cleaning of the finned coil every three months
- Cleaning of the fan grills
- Cleaning of condensate drain pan.
- Cleaning of water filters.
- Checking the ventilation openings on the base are free of leaves, bushes or anything else that may obstruct air flow.

For units installed near the sea, the intervals between maintenance should be halved.

**Never perform any cleaning operations** before having disconnected the unit from the mains power supply. Make sure power is not connected before proceeding.

### CHEMICAL WASHING

It is recommended to chemically flush the plate heat exchanger after every 3 years of operation. To perform this operation, contact a specialist technician.

### REFRIGERANT GAS CHARGE

The chillers are filled with R410A refrigerant gas and tested in the factory.

In normal conditions, there should be no need for the Technical Service to intervene to check the refrigerant gas.

However, over time, small leaks may develop at the joints leading to loss of refrigerant and draining of the circuit, causing the unit to function poorly.

In this case, the leaks of refrigerant must be identified and repaired and the refrigerant circuit recharged.

Proceed as follows:

- Empty and dry the entire refrigerant circuit using a vacuum pump connected to the low and high pressure tap until the vacuumometer reads about 10 Pa.  
Wait a couple of minutes and check that this value does not rise to more than 50 Pa.
- Connect the refrigerant gas cylinder or a filling cylinder to the low pressure line pressure gauge connection
- Charge the quantity of refrigerant indicated on the unit's rating plate.
- Always check the superheating and subcooling values, which should be between 5 and 10°C and 4 and 8°C.
- After a couple of hours operation, check that the liquid indicator indicates a dry circuit (dry-green).

 **In the event of partial leaks**, the circuit must be completely emptied before being recharged.

**The R410A refrigerant** must only be charged in the liquid state.

**Operating conditions** other than rated conditions may produce considerably different values.

**Tightness testing** or identification of leaks must only be carried out using R410A refrigerant gas, checking with a suitable leak detector.

The refrigerant circuit **must not be charged** with a refrigerant other than that indicated on the rating plate and in this manual.

The use of a different refrigerant may cause serious damage to the compressor.

 Oxygen, acetylene or other flammable or poisonous gases **must never be used** in the refrigerant circuit as they may cause explosion or poisoning.

Oils other than those indicated **must not be used**.

The use of different oil may cause serious damage to the compressor.

**The unit must be disposed of** according to the legislation in force in the country concerned

Description	Menu	Parameter no.	UOM
Enable domestic hot water set point: 0 = Economy, 1 = Comfort	Mn00	0015	
Domestic hot water Economy set point	Mn00	0022	°C
Domestic hot water Comfort set point	Mn00	0023	°C
User password	Mn00	0036	
Enable remote contact: 0= remote contact enabled, 1= remote contact disabled (selection from keypad only)	Mn01	0100	
Automatic mode changeover set point in HEATING	Mn01	0106	°C
Automatic mode changeover differential in HEATING	Mn01	0107	°C
Automatic mode changeover set point in COOLING	Mn01	0108	°C
Automatic mode changeover differential in COOLING	Mn01	0109	°C
Type of outlet heater operation: 0 = Supplementary , 1 = Replacement	Mn01	010G	
Type of boiler operation: 0 = Supplementary , 1 = Replacement	Mn01	010H	
Maximum return set point limit in cooling mode (Tm1)	Mn01	0128	°C
Outside minimum temperature corresponding to max. return temperature (Te1)	Mn01	0129	°C
Enable compensation for room humidity, ZONE LT3: 0= Disabled , 1= Enabled	Mn01	012N	
Room relative humidity value to start increasing water outlet temperature set point, ZONE LT3	Mn01	012P	%
Maximum outlet temperature hysteresis corresponding to 100% relative humidity	Mn01	012R	°C
Minimum return set point limit in cooling mode (Tm2)	Mn01	0130	°C
Maximum outside temperature corresponding to min. return temperature (Te2)	Mn01	0131	°C
Maximum outlet temperature set point limit in cooling mode (Tm1)	Mn01	0132	°C
Minimum outside temperature corresponding to max. outlet temperature (Te1)	Mn01	0133	°C
Minimum outlet temperature set point limit in cooling mode (Tm2)	Mn01	0134	°C
Maximum outside temperature corresponding to min. outlet temperature (Te2)	Mn01	0135	°C
Maximum outlet temperature set point limit in cooling mode (Tm1)	Mn01	0136	°C
Minimum outside temperature corresponding to max. outlet temperature (Te1)	Mn01	0137	°C
Minimum outlet temperature set point limit in cooling mode (Tm2)	Mn01	0138	°C
Maximum outside temperature corresponding to min. outlet temperature (Te2)	Mn01	0139	°C
Inside temperature to enable frost protection	Mn01	0140	°C
Outside air temperature for frost protection	Mn01	0141	°C
Enable SYSTEM compensation curve 0= Disabled 1= Enabled	Mn01	0152	
Fixed return water temperature set point in HEATING	Mn01	0153	°C
Enable SYSTEM compensation curve: 0= Disabled, 1= Enabled	Mn01	0154	
Fixed return water temperature set point in COOLING	Mn01	0155	°C
Enable compensation for room humidity, SYSTEM: 0= Disabled , 1= Enabled	Mn01	0156	
Room relative humidity value to start increasing SYSTEM return water set point	Mn01	0157	%
Maximum return temperature hysteresis corresponding to 100% relative humidity	Mn01	0158	°C
SYSTEM compensation curve number	Mn01	0159	
Enable contact as: 0= Alarm signal, 1= Dehumidifier, 3= Secondary circuit pump	Mn01	015A	
Enable compensation curve for zone LT3 0= Disabled 1= Enabled	Mn01	015E	
Enable room temperature influence on SYSTEM 0= Disabled 1= Enabled	Mn01	0163	
SYSTEM Room Authority	Mn01	0164	%
Minimum set point limit for SYSTEM curve	Mn01	0165	°C
Maximum set point limit for SYSTEM curve	Mn01	0166	°C
Enable compensation curve for zone LT1 0= Disabled 1= Enabled	Mn01	0167	
Enable compensation curve for zone LT1: 0= Disabled, 1= Enabled	Mn01	0169	
Enable compensation for room humidity, ZONE LT1: 0= Disabled , 1= Enabled	Mn01	0171	
Room relative humidity value to start increasing water outlet temperature set point, ZONE LT1	Mn01	0172	%
Maximum outlet temperature hysteresis corresponding to 100% relative humidity	Mn01	0173	°C
Zone LT1 compensation curve number	Mn01	0174	
Enable room temperature influence on LT1 0= Disabled 1= Enabled	Mn01	0178	
LT1 Room Authority	Mn01	0179	%
MINIMUM outlet set point limit for compensation curve in zone LT1	Mn01	0180	°C
MAXIMUM outlet set point limit for compensation curve in zone LT1	Mn01	0181	°C
Enable compensation curve for zone LT2 0= Disabled 1= Enabled	Mn01	0182	
Enable compensation curve for zone LT2: 0= Disabled, 1= Enabled	Mn01	0184	
Enable compensation for room humidity, ZONE LT2: 0= Disabled , 1= Enabled	Mn01	0186	
Room relative humidity value to start increasing water outlet temperature set point, ZONE LT2	Mn01	0187	%
Maximum outlet temperature hysteresis corresponding to 100% relative humidity	Mn01	0188	°C
Zone LT2 compensation curve number	Mn01	0189	
Enable room temperature influence on LT2 0= Disabled 1= Enabled	Mn01	0193	
LT2 Room Authority	Mn01	0194	%
MINIMUM outlet set point limit for compensation curve in zone LT2	Mn01	0195	°C
MAXIMUM outlet set point limit for compensation curve in zone LT2	Mn01	0196	°C
Electric heater operating mode: 0 = heat pump only, 1 = electric heater only, 2 = heat pump + electric heater	Mn02	0202	
Domestic hot water set point with heater	Mn02	0209	°C



Description	Menu	Parameter no.	UOM
Domestic hot water temperature set point for Legionella prevention	Mn02	0211	°C
Legionella prevention cycle day MONDAY (0=no 1=yes)	Mn02	0213	
Legionella prevention cycle day TUESDAY (0=no 1=yes)	Mn02	0214	
Legionella prevention cycle day WEDNESDAY (0=no 1=yes)	Mn02	0215	
Legionella prevention cycle day THURSDAY (0=no 1=yes)	Mn02	0216	
Legionella prevention cycle day FRIDAY (0=no 1=yes)	Mn02	0218	
Legionella prevention cycle day SATURDAY (0=no 1=yes)	Mn02	0219	
Legionella prevention cycle day SUNDAY (0=no 1=yes)	Mn02	0220	
Legionella prevention cycle time	Mn02	0221	h
Enable Legionella prevention function 0 = Not enabled 1 = Enabled	Mn02	0222	
Legionella prevention function with: 0 = heat pump only 1 = electric heater only 2 = heat pump + electric heater	Mn02	0223	
Maximum Legionella prevention function duration	Mn02	0225	min.
Enable electric heater: 0 = Heater not enabled, 1 = Heater enabled	Mn03	0300	
Enable boiler: 0 = Boiler not enabled, 1 = Boiler enabled	Mn03	0301	
Activation for low outside air temperature: 0 = Function not enabled, 1 = Function enabled	Mn03	0303	
Outside air temperature to enable electric heater	Mn03	0304	°C
Activation for low outside air temperature: 0 = Function not enabled, 1 = Function enabled	Mn03	0306	
Outside air temperature to enable boiler	Mn03	0307	°C
Minimum outside air temperature for heat pump operation (make sure the value shown in the table is set)	Mn03	0311	°C
Electric heater activation delay time (allows the heat pump to reach steady operation and thus avoid activating the heater when not needed)	Mn06	0616	min.
Integration time to activate outlet electric heaters	Mn06	0617	°C*sec
Boiler activation delay time (allows the heat pump to reach steady operation and thus avoid activating the boiler when not needed)	Mn06	0618	min.
Integration time to activate boiler	Mn06	0619	°C*sec
Enable manual heater operation	Mn06	0620	
Relationship between plant and ambient: 0 = Unit work on ambient request, 1 = Unit work independent	Mn01	011D	
Installer password	Mn01	011G	
Enable compensation curve for LT3 in HEATING 0= Disabled (fixed set point operation) 1= Enabled	Mn01	011R	
Enable compensation curve for zone LT3: 0= Disabled, 1= Enabled	Mn01	011T	
Fixed water outlet temperature set point for LT3 in HEATING	Mn01	011U	°C
Zone LT3 compensation curve number	Mn01	012A	
Enable room temperature influence on LT3 0= Disabled 1= Enabled	Mn01	012D	
LT3 Room Authority	Mn01	012E	%
MINIMUM outlet set point limit for compensation curve in zone LT3	Mn01	012F	°C
MAXIMUM outlet set point limit for compensation curve in zone LT3	Mn01	012G	°C
Maximum outlet temperature set point limit in cooling mode (Tm1)	Mn01	012H	°C
Minimum outside temperature corresponding to max. outlet temperature (Te1)	Mn01	012J	°C
Minimum outlet set point limit in cooling mode (Tm2)	Mn01	012L	°C
Minimum outside temperature corresponding to min. outlet temperature (Te2)	Mn01	012M	°C
Activation of system pump operation at intervals: 0= system pump always on, 1=system pump operation at intervals	Mn01	0143	
System pump operating time in sniffing mode	Mn01	0147	
System pump off time between one sniffing cycle and the next	Mn01	0148	
Enable contact as: 0 =Reduced electricity rate, 1=Stop operation due to excess power consumption	Mn01	015D	
Enable compensation curve for LT1 in HEATING 0= Disabled (fixed set point operation) 1= Enabled	Mn01	0168	
Fixed water outlet temperature set point for LT1 in HEATING	Mn01	0170	°C
Enable compensation curve for LT2 in HEATING 0= Disabled (fixed set point operation) 1= Enabled	Mn01	0183	
Fixed water outlet temperature set point for LT2 in HEATING	Mn01	0185	°C
Minimum heat pump operating time for system	Mn02	0226	
Maximum heat pump operating time to reach domestic hot water set point	Mn02	0227	
Three-way valve travel time for domestic hot water production	Mn02	0231	sec.
BT1 Heat exchanger water inlet temperature probe	Mn09	0900	°C
BT2 Heat exchanger water outlet temperature probe	Mn09	0901	°C
BT8 Domestic hot water probe	Mn09	0902	°C
BT7 Unit control air temperature probe	Mn09	0903	°C
BT9 Storage tank probe	Mn09	0904	°C
BT11 Outside air temperature probe for set point management	Mn09	0905	°C
BP1 Condenser/evaporator control pressure transducer	Mn09	0906	bar

Installer: \_\_\_\_\_ Designer: \_\_\_\_\_

Type of application: \_\_\_\_\_

Street \_\_\_\_\_ number \_\_\_\_\_

City/town \_\_\_\_\_ Postcode/ZIP code \_\_\_\_\_ Province/State \_\_\_\_\_

Unit model installed \_\_\_\_\_ Serial number \_\_\_\_\_

Is there a system design? YES  NO  If YES, has the system been developed completely in accordance with the design? YES  NO

Installation date: \_\_\_\_\_

**Systems included:**

- Winter heating AT (radiators)
- Winter heating MT (fan coil)
- Winter heating BT (radiant panels)
- Summer cooling
- DHW production
- Solar thermal installed

Mark the type of system installed and describe the components in the corresponding tables

**Heating system circuit**

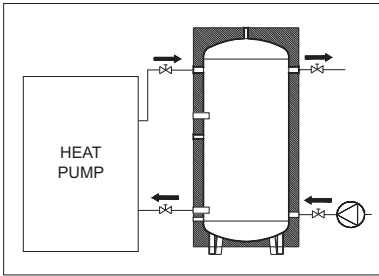

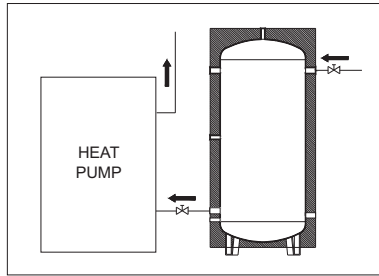



	Storage tank	Additional expansion vessel
Volume [l]		
Type/model		
	Secondary pump	
Installed?		
Type/model		

Hot water set point: \_\_\_\_\_ °C

Cold water set point: \_\_\_\_\_ °C

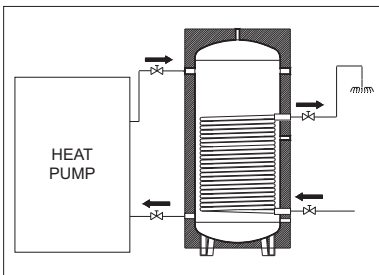
**Domestic hot water circuit**

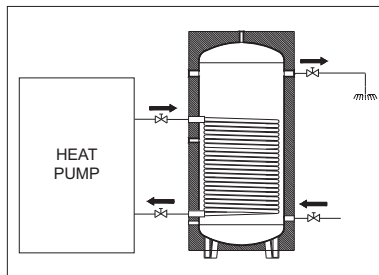



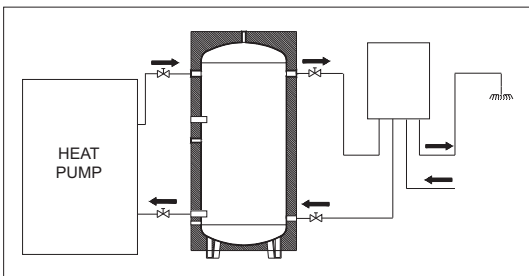

	Storage tank with coil	Storage cylinder	Expansion vessel
Volume [l]			
Type/model			
Coil water volume [l]			
Coil heat exchange area [m <sup>2</sup> ]			

Domestic hot water set point: \_\_\_\_\_ °C

CONCERNING UNIT INSTALLATION OPERATIONS AND SETUP FOR COMMISSIONING,

## HAVE THE FOLLOWING CHECKS BEEN COMPLETED?

Components installed (as described in the paragraph on "Water circuit connections")	YES	NO
• Two pressure gauges with a suitable scale are installed on the inlet and outlet	<input type="checkbox"/>	<input type="checkbox"/>
• Shut-off valves are installed on the heating system circuit and domestic hot water circuit inlet and outlet	<input type="checkbox"/>	<input type="checkbox"/>
• Two thermometers are installed, on the inlet and outlet	<input type="checkbox"/>	<input type="checkbox"/>
• All pipes are insulated with suitable vapour barrier material to prevent formation of condensate and heat loss, with control and shut-off devices protruding from the insulation	<input type="checkbox"/>	<input type="checkbox"/>
• Drain valves are installed at the lowest points in the system	<input type="checkbox"/>	<input type="checkbox"/>
• Automatic or manual air vent valves are installed at the highest points in the system	<input type="checkbox"/>	<input type="checkbox"/>
• An additional expansion vessel is installed on the system if the standard vessel is insufficient	<input type="checkbox"/>	<input type="checkbox"/>
• Vibration damper joints are installed on the inlet and outlet water pipes	<input type="checkbox"/>	<input type="checkbox"/>
• A low-loss header is installed if the water content is insufficient	<input type="checkbox"/>	<input type="checkbox"/>
• Vibration damper supports are installed on the unit	<input type="checkbox"/>	<input type="checkbox"/>
• The domestic hot water production system is installed	<input type="checkbox"/>	<input type="checkbox"/>
• The safety valve is installed and suitably sized	<input type="checkbox"/>	<input type="checkbox"/>
• The domestic hot water expansion vessel is installed and suitably sized	<input type="checkbox"/>	<input type="checkbox"/>

Checks (as described in the paragraph on "Checking and starting up the unit")	CHECKED
• Two pressure gauges with a suitable scale are installed on the inlet and outlet	<input type="checkbox"/>
• The unit is positioned as described in the chapter on "Positioning" in this manual	<input type="checkbox"/>
• The filter is installed on the system return/inlet as close as possible to the unit and in a position that is easy to access for maintenance. <b>REQUIRED</b> component, this must be installed before water circulates through the heat exchanger <b>otherwise the warranty will be void</b>	<input type="checkbox"/>
• The filter is installed on the domestic hot water return/inlet as close as possible to the unit and in a position that is easy to access for maintenance. <b>REQUIRED</b> component, this must be installed before water circulates through the heat exchanger <b>otherwise the warranty will be void</b>	<input type="checkbox"/>
• (Water-to-water units only) The filter is installed on the source return/inlet as close as possible to the unit and in a position that is easy to access for maintenance. <b>REQUIRED</b> component, this must be installed before water circulates through the heat exchanger <b>otherwise the warranty will be void</b>	<input type="checkbox"/>
• The flow switch is installed on the unit's outlet to the heating system circuit and is electrically connected. <b>REQUIRED</b> component, this must be installed before water circulates through the heat exchanger <b>otherwise the warranty will be void</b>	<input type="checkbox"/>
• (Water-to-water units only) The flow switch is installed unit's outlet to the source circuit and is electrically connected. <b>REQUIRED</b> component, this must be installed before water circulates through the heat exchanger <b>otherwise the warranty will be void</b>	<input type="checkbox"/>

Checks (as described in the paragraph on "Checking and starting up the unit")	CHECKED
• The connection pipes are suitably supported so that these do not weigh on the appliance	<input type="checkbox"/>
• Correct sizing of the expansion vessel has been verified according to the system water content and the expected operating temperature	<input type="checkbox"/>
• The position of the outside air temperature probe complies with the information provided in the installation manual	<input type="checkbox"/>
• The position of the room controllers installed complies with the information provided in the installation manual	<input type="checkbox"/>
• The position of the DHW storage tank probe complies with the information provided in the installation manual	<input type="checkbox"/>
• (Units with heat recovery only) The non-return valve is fitted on the domestic hot water circuit	<input type="checkbox"/>
• All safety conditions have been respected	<input type="checkbox"/>
• The unit is fixed to the surface it rests on	<input type="checkbox"/>
• Water connections have been carried out as indicated in the installation manual	<input type="checkbox"/>
• All water connections are tight	<input type="checkbox"/>
• All electrical connections are tight	<input type="checkbox"/>
• Make sure the water circuit has been washed and drained	<input type="checkbox"/>
• There is no air in the system (vent if necessary)	<input type="checkbox"/>
• The valves on the water circuit are open	<input type="checkbox"/>
• Electrical connections have been carried out correctly	<input type="checkbox"/>
• Voltage is within a tolerance of 10% of the rated voltage for the unit	<input type="checkbox"/>
• Unbalance between phases is less than 2%, for three-phase units	<input type="checkbox"/>
• Maintenance clearances comply with the specifications in the Installation manual under the section on POSITIONING	<input type="checkbox"/>
• Power supply electrical complies with the data on the rating plate and specified in the Installation manual under the section on MAINS POWER SUPPLY CONNECTION	<input type="checkbox"/>
• The system water content complies with the specifications in the Installation manual under the section on WATER CONNECTIONS	<input type="checkbox"/>
• Suitable water flow-rate for operation of the entire unit is guaranteed as specified in the Installation manual under the section on WATER CONNECTIONS	<input type="checkbox"/>
• (Air-to-water units only) The system has been protected with antifreeze, respecting the quantities shown in the Installation manual under the section on WATER CONNECTIONS	<input type="checkbox"/>
• The DHW storage tank has been fitted with an electric heater for Legionella prevention	<input type="checkbox"/>

It is hereby declared that the site and access to the site where the unit to be operated or serviced is installed has been made safely accessible in compliance with all safety standards specified by Italian law 81/08 in force. A supervisor must be present on site to inform workers of residual risks in the workplace.

**WARNING:**

Failure to complete commissioning due to causes not attributable to the unit will require a second visit, to be charged to the customer directly by the local service centre.

Installer's signature \_\_\_\_\_

Date \_\_\_\_\_





*Professional*

Sede Legale: Via L.Seitz, 47 - 31100 Treviso

Sede Amm.va: Via Sarson, 57/S - 36061 Bassano del Grappa (VI) - Italia